

# **RM4-TR**

DIN Rail Mount  
Totaliser/Ratemeter  
Process Monitor/Controller  
Operation and Instruction Manual

---

---

# Table of Contents

---

<b>Introduction</b> . . . . .	<b>3</b>
Entry to setup and scaling functions. . . . .	3
Inputs & outputs . . . . .	4
<b>Mechanical installation</b> . . . . .	<b>5</b>
<b>Electrical installation</b> . . . . .	<b>6</b>
Power supply connections. . . . .	7
Relay connections. . . . .	7
Reset input . . . . .	7
Count up/down operation . . . . .	7
Remote input connections. . . . .	7
Equiflow and Rotapulse wiring and link settings . . . . .	7
Input circuit . . . . .	8
Signal input connections . . . . .	9
Configuring the input board . . . . .	11
Input link settings. . . . .	11
<b>Ratometer explanation of functions</b> . . . . .	<b>12</b>
Examples. . . . .	19
Error Messages . . . . .	21
<b>Ratometer Function Table.</b> . . . . .	<b>22</b>
<b>Totaliser Explanation of Functions</b> . . . . .	<b>24</b>
Examples . . . . .	27
<b>Totaliser Function Table</b> . . . . .	<b>30</b>
<b>Both Mode</b> . . . . .	<b>32</b>
Both Mode Function Table . . . . .	32
<b>Alarm relays</b> . . . . .	<b>35</b>
Easy Alarm Access . . . . .	37
<b>Specifications</b> . . . . .	<b>38</b>
Technical Specifications . . . . .	38
Output Options . . . . .	38
Physical Characteristics . . . . .	38
<b>Guarantee and Service</b> . . . . .	<b>39</b>

---

# 1 Introduction

---

This manual contains information for the installation and operation of the RM4-TR Monitor. The instrument may be set to operate as a ratemeter or totaliser or allow toggling between rate and total displays. The **SEt OPEr** function allows selection of one of these three modes. A brief description of each mode is given below. The three modes of operation are:

1. **totl** - totaliser/counter display.

The input pulses are totalised, scaled in engineering units and displayed e.g. a display showing Total litres, mm etc. Count up or count down operation is possible via the **SET** electrical input and is controlled by the **5.1 RP** function. A total and grand total may be viewed and reset separately. The grand total is a separate total memory which adds together all the previous totals.



Explanation and examples of the totaliser functions are given in the "Totaliser Explanation of Functions" chapter.

2. **FRER** - frequency/rate display.

The frequency or rate of the input may be scaled in engineering units and displayed e.g. a display showing R.P.M, Bottles/min., Litres/hour etc.. For low frequency inputs (input always below 1kHz) there is an option of displaying either rate or period.

Explanation and examples of the ratemeter functions are given in the "Ratemeter Explanation of Functions" chapter.

3. **both** - total/rate display (display may be toggled to either total or rate)

This mode is primarily used when the display is required to toggle between a rate and total display via an external contact closure or via the front panel  and  buttons (only fitted on certain display options). For low frequency inputs (input always below 1kHz) there is an option of toggling between rate/total or rate/period. A total and grand total may be viewed and reset separately.

**Note:** modes **PERd** & **5.Pr-d** seen at the **SEt OPEr** function are not covered in this manual.

Two standard inbuilt relays provide alarm/control functions. A standard transmitter supply of 5VDC or 24VDC (link selectable) unregulated is also provided on both AC and DC powered models.

Various combinations of one or two optional extra relays, analog (4-20mA, 0-1V or 0-10V) retransmission/PI control or serial (RS232, RS485 or RS422) communications and an isolated 12 or 24VDC isolated transmitter supply may also be provided as an option.



Unless otherwise specified at the time of order, your RM4 has been factory set to a standard configuration. Like all other RM4 series instruments the configuration and calibration is easily changed by the user. Initial changes may require dismantling the instrument to alter PCB links, other changes are made by push button functions. Full electrical isolation between power supply, input voltage or current and retransmission output is provided by the RM4, thereby eliminating grounding and common voltage problems. This isolation feature makes the RM4 ideal for interfacing to computers, PLCs and other data acquisition devices.

The RM4 series of DIN Rail Process Modules are designed for high reliability in industrial applications. The 5 digit LED display provides good visibility, even in areas with high ambient light levels. A feature of the RM4 is the programmable display brightness function, this allows the unit to be operated with low display brightness to reduce the instrument power consumption and to improve readability in darker areas. To reduce power consumption in normal use the display can be programmed to automatically dim or blank after a set time.

## 1.1 Entry to setup and scaling functions

The RM4 setup and calibration functions are configured through a push button sequence. Two levels of access are provided for setting up and calibrating:-

**FUNC** mode (simple push button sequence) allows access to alarm relay, preset value & display brightness functions. **CAL** mode (power up sequence plus push button sequence) allows access to all functions including calibration parameters.

Push buttons located at the front of the instrument are used to alter settings. Once **CAL** or **FUNC** mode has been entered you can step through the functions, by pressing and releasing the  push button, until the required function is reached. Changes to functions are made by pressing the  or  push button (in some cases both simultaneously) when the required function is reached.

## Entering **CAL** Mode

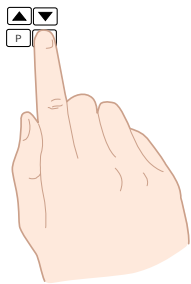

1. Remove power from the instrument. Hold in the **F** button and reapply power. The display will indicate **CAL** as part of the "wake up messages" when the **CAL** message is seen you can release the button.

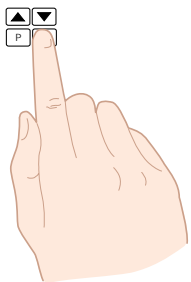

2. When the "wake up" messages have finished and the display has settled down to its normal reading press, then release the **F** button.

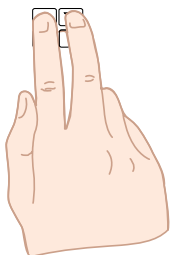

3. Within 2 seconds of releasing the **F** button press, then release the **▲** and **▼** buttons together. The display will now indicate **FUNC** followed by the first function.

Note: If step 1 above has been completed then the instrument will remain in this **CAL** mode state until power is removed. i.e. there is no need to repeat step 1 when accessing function unless power has been removed.

## Entering **FUNC** Mode

No special power up procedure is required to enter **FUNC** mode.



1. When the "wake up" messages have finished and the display has settled down to its normal reading press, then release the **F** button.

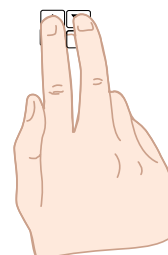

2. Within 2 seconds of releasing the **F** button press, then release the **▲** and **▼** buttons together. The display will now indicate **FUNC** followed by the first function.

### 1.2 Inputs & outputs

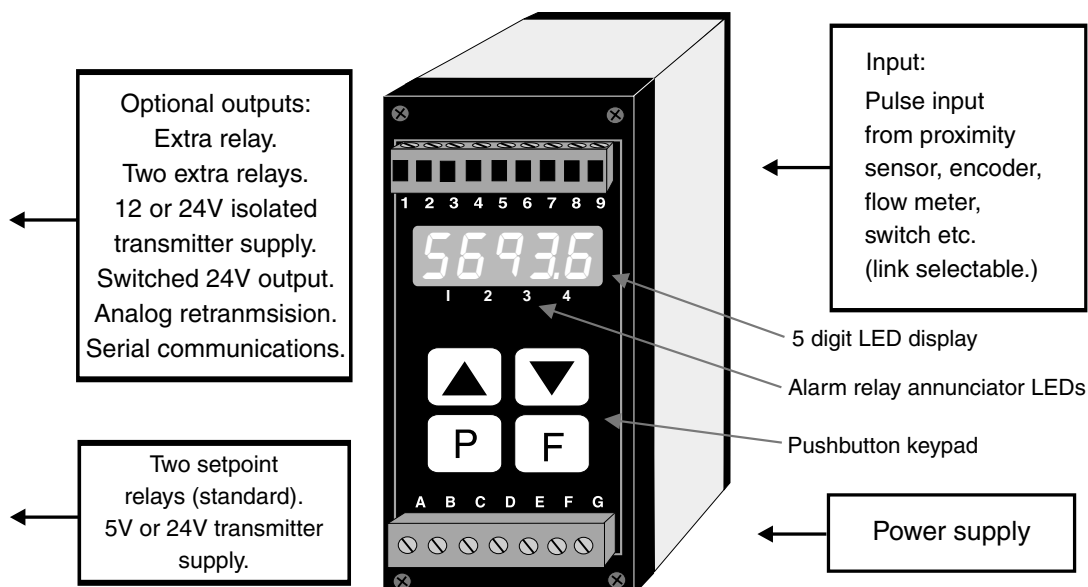

Example: Entering **FUNC** mode to change alarm 1 high function **A 1H<sub>1</sub>** from **OFF** to **100**

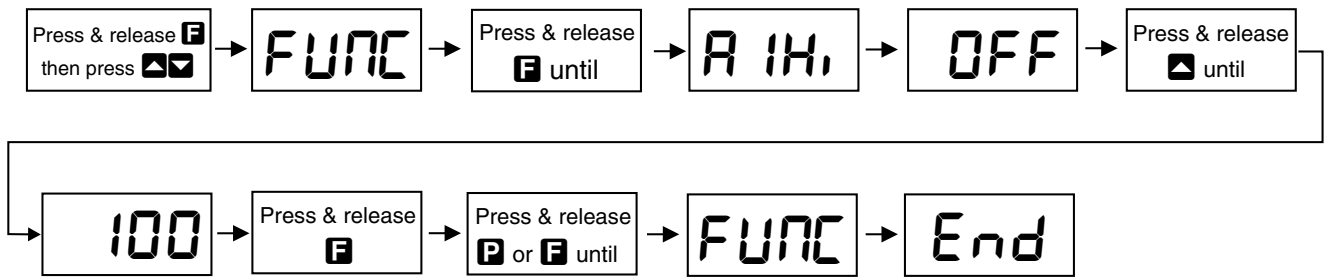

Example: Entering **CAL** mode to change decimal point **dCPT** function from **0** to **0.02**

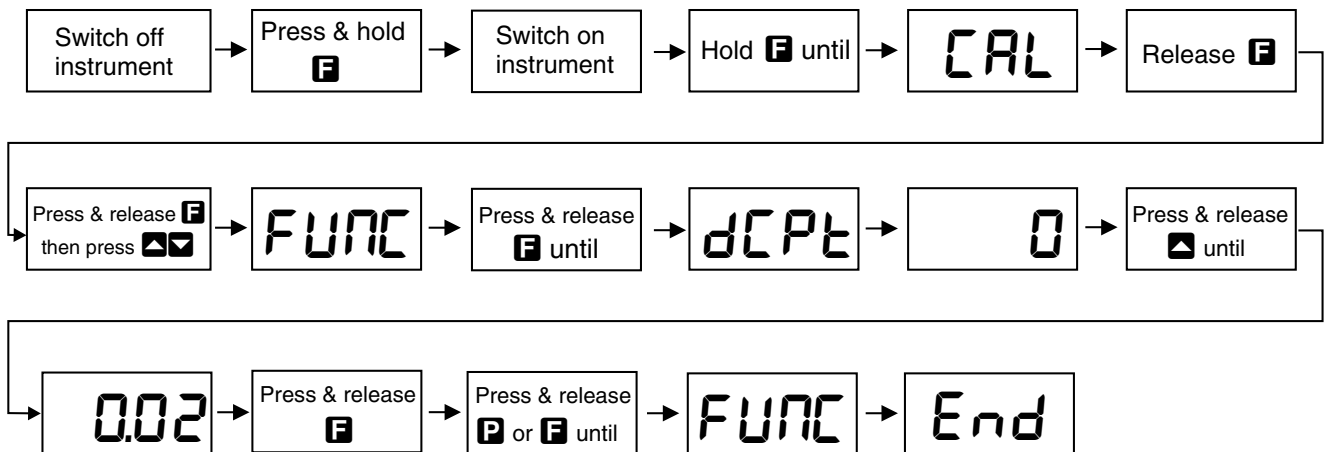

## 2 Mechanical installation

The RM4 is designed for DIN rail, horizontal mounting. The instrument snaps on 35mm DIN standard rails (EN50022). Cut the DIN rail to length and install where required. To install the RM4, simply clip onto the rail as shown below. To remove the RM4 lever the lower arm downwards using a broad bladed screwdriver to pull the clip away from the DIN rail.

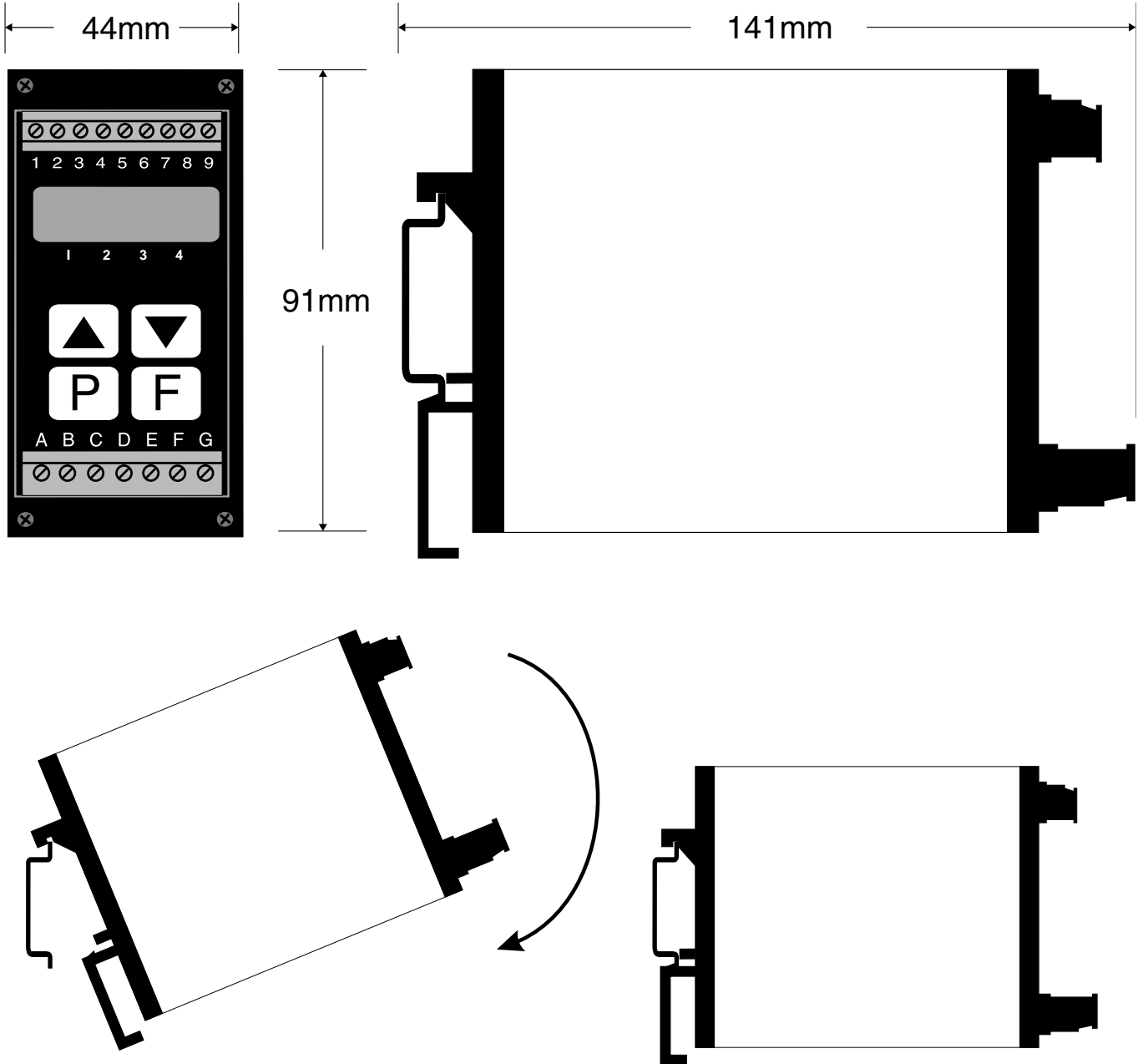

### 3 Electrical Installation

The RM4 Meter is designed for continuous operation and no power switch is fitted to the unit. It is recommended that an external switch and fuse be provided to allow the unit to be removed for servicing.

The terminal blocks allow for wires of up to 2.5mm<sup>2</sup> to be fitted for power supply and relays 1 and 2 or 1.5mm<sup>2</sup> for input signal connections and optional outputs. Connect the wires to the appropriate terminals as indicated below. Refer to other details provided in this manual to confirm proper selection of voltage, polarity and input type before applying power to the instrument. When power is applied the instrument will cycle through a display sequence, indicating the software version and other status information, this indicates that the instrument is functioning. Acknowledgement of correct operation may be obtained by applying an appropriate input to the instrument and observing the resultant reading.

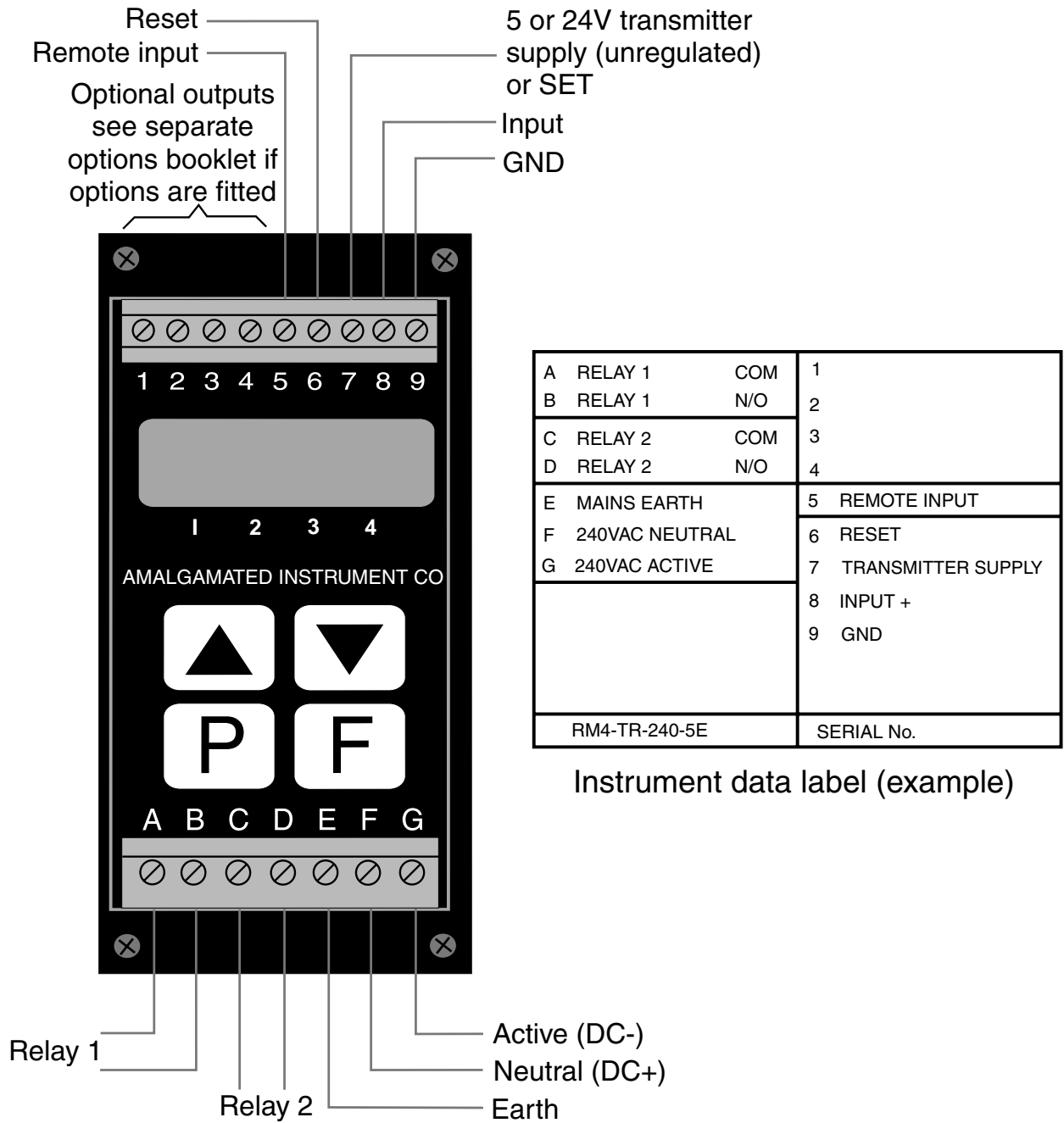

### 3.1 Power supply connections

The power supply for the instrument is factory fitted and is of a fixed type. If you are unsure of the supply requirement for your instrument it can be determined by the model number on the instrument label:-

RM4-TR-240-.....	Requires 240VAC
RM4-TR-110-.....	Requires 110VAC
RM4-TR-32-.....	Requires 32VAC
RM4-TR-24-.....	Requires 24VAC
RM4-TR-DC-.....	Requires between 12 and 48VDC

### 3.2 Relay connections

The RM4 is supplied with two alarm relays as standard. Relay 1 is connected across terminals A and B. Relays 2 is connected across terminals C and D. One or two extra relays are optionally available. Relays 1 & 2 are single pole, single throw types (form A) and are rated at 5A, 240VAC into a resistive load. Relays 3 and 4 are form A rated 0.5A resistive 30VAC or DC. The relay contacts are voltage free and may be programmed for normally open or normally closed operation. If only 3 relays are fitted and no other options are fitted then Relay 3 can be configured as form C.

### 3.3 Reset input

The reset input is between terminal 6 and terminal 9. A contact closure or open collector transistor input can be used to reset the total. See the **CLR SET** function for details of the counter reset modes available. In count up totaliser operation the display can be set to reset automatically when a total is reached, see the **CNTR FSET** function for details. The remote input (see 3.5 below) can be used to reset the grand total.

### 3.4 Count up/down operation

The SET input may be used in up count/down count operation of the totaliser. Control of mode of operation is via the **SET UP** function and via the state of the SET input (open circuit or short circuit to ground via wire link, contact closure or open collector transistor input). See **SET UP** function for description and operation table.

Internal link settings required:

- LK10 "KEY3" IN
- LK11 "5VEX" OUT
- LK16 (main circuit board) "24V" OUT
- LK17 (main circuit board) "24V" OUT

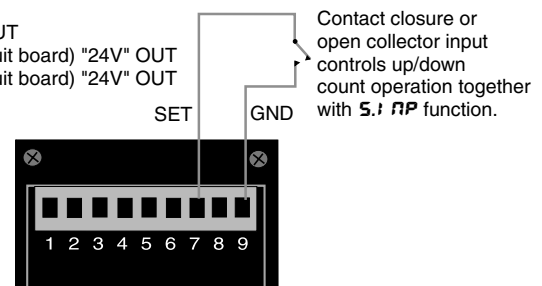

### 3.5 Remote input connections

The selected remote input function can be operated via an external contact closure via a switch, relay or open collector transistor switch.

A momentary action is required for functions such as **ZERO**, a latching switch or normally closed momentary switch may be required for functions such as peak hold.

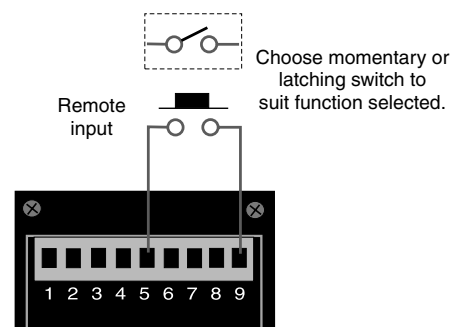

### 3.6 Equflow and Rotapulse wiring and link settings

Equflow and Rotapulse flowmeters are commonly supplied with this model. Note that sensor supplies are available only on AC powered models. Wiring and link settings are as shown below:

#### Equflow:

**Colour code:** White - signal + (terminal 8), Brown - +5V (terminal 7), Green and shield - ground (terminal 9).

**Input link settings:** Links in are LK2 (BIAS), LK4 (HYST), LK6 (GND), LK11 (5VEX) all other links are out.

#### Rotapulse:

**Colour code:** Black - signal + (terminal 8), Brown - +24V (terminal 7), Blue - ground (terminal 9).

**Input link settings:** Links in are LK2 (BIAS), LK3 (DC), LK4 (HYST), LK9 (VCC), LK16 & 17 (24V) all other links are out.



### 3.8 Signal input connections

#### INDUCTIVE SENSOR

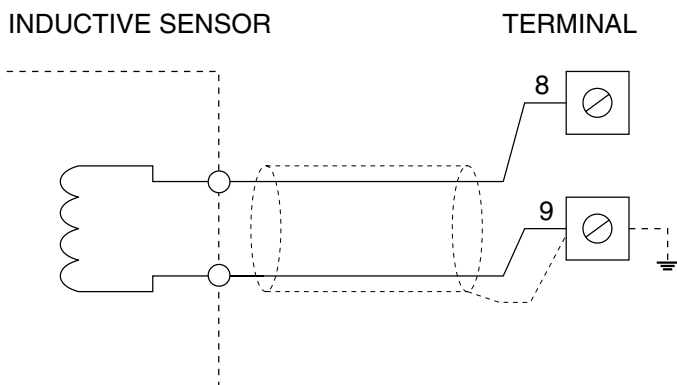

#### Inductive Sensor (48V RMS Max)

Typical Internal Link Settings

FREQ	Link LK1	in or out *
BIAS	Link LK2	out
DC	Link LK3	in
HYST	Link LK4	in or out *
HYST2	Link LK5	in or out *
GND	Link LK6	in or out *
LOW FREQ	Link LK7	out
AC	Link LK8	out
VCC	Link LK9	out

\* See "Input link settings, section 3.10".

#### AC MEASUREMENT

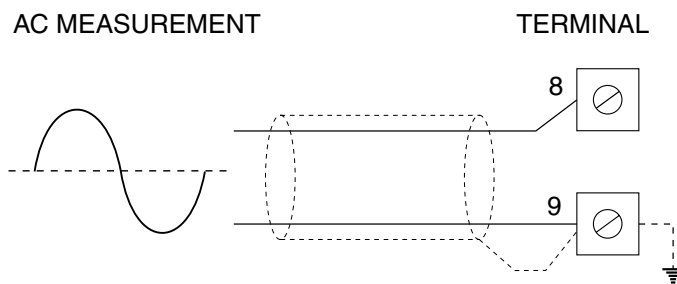

#### AC Measurement (48V RMS Max)

Typical Internal Link Settings

FREQ	Link LK1	in or out *
BIAS	Link LK2	out
DC	Link LK3	in or out *
HYST	Link LK4	in or out *
HYST2	Link LK5	in or out *
GND	Link LK6	in or out *
LOW FREQ	Link LK7	out
AC	Link LK8	out
VCC	Link LK9	out

\* See "Input link settings, section 3.10".

#### SQUARE WAVE INPUT

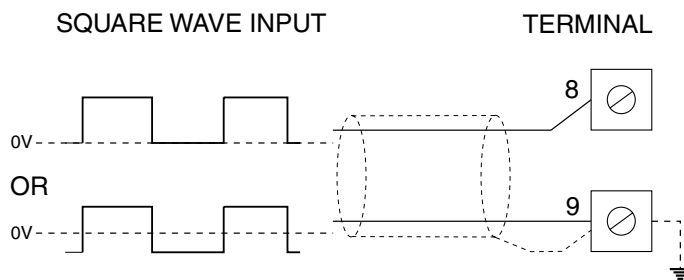

#### Square wave (48V Max)

Typical Internal Link Settings

FREQ	Link LK1	out
BIAS	Link LK2	in or out *
DC	Link LK3	in
HYST	Link LK4	in or out *
HYST2	Link LK5	in or out *
GND	Link LK6	in or out *
LOW FREQ	Link LK7	out
AC	Link LK8	out
VCC	Link LK9	out

\* See "Input link settings, section 3.10".

#### CONTACT CLOSURE

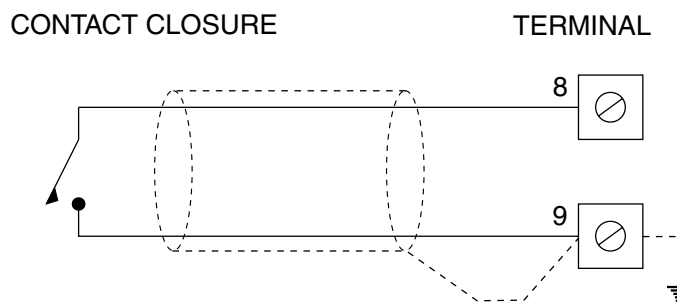

#### Voltage free contact

Typical Internal Link Settings

FREQ	Link LK1	out
BIAS	Link LK2	in
DC	Link LK3	in
HYST	Link LK4	in
HYST2	Link LK5	out
GND	Link LK6	out
LOW FREQ	Link LK7	in
AC	Link LK8	out
VCC	Link LK9	in

\* See "Input link settings, section 3.10".

#### NAMUR SENSOR

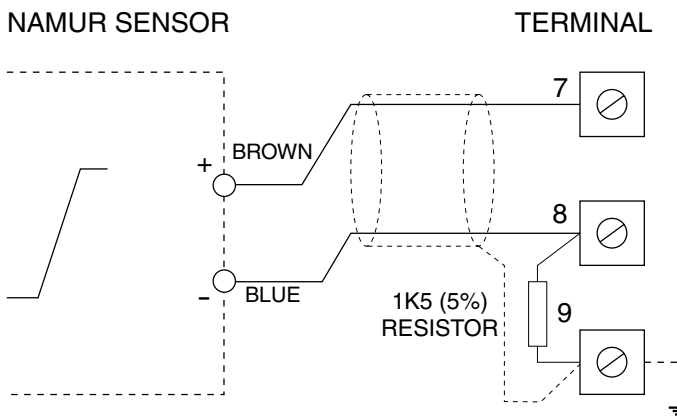

#### Namur sensor

Typical Internal Link Settings

FREQ	Link LK1	out
BIAS	Link LK2	in
DC	Link LK3	in
HYST	Link LK4	in
HYST2	Link LK5	out
GND	Link LK6	in
LOW FREQ	Link LK7	out
AC	Link LK8	out
VCC	Link LK9	out

\* See "Input link settings, section 3.10".

**NPN TRANSISTOR**

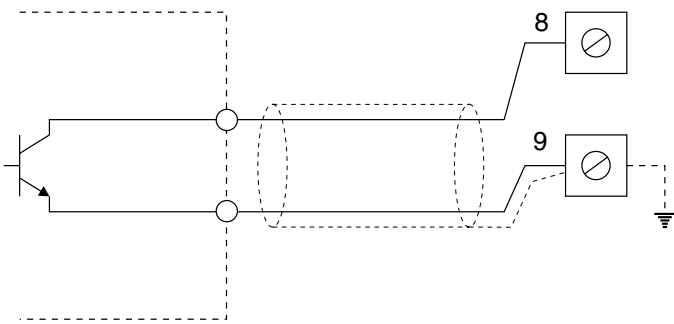

**TERMINAL**

**NPN transistor sensor**

Typical Internal Link Settings

FREQ	Link LK1	out
BIAS	Link LK2	in
DC	Link LK3	in
HYST	Link LK4	in or out *
HYST2	Link LK5	in or out *
GND	Link LK6	out
LOW FREQ	Link LK7	out
AC	Link LK8	out
VCC	Link LK9	in

\* See "Input link settings, section 3.10".

Note: the transducer may require an external DC supply. This may be provided from a remote power source, by a DC output on terminal 7 or optional isolated DC supply (see "Transducer power supply").

**NPN TRANSISTOR 3 WIRE**

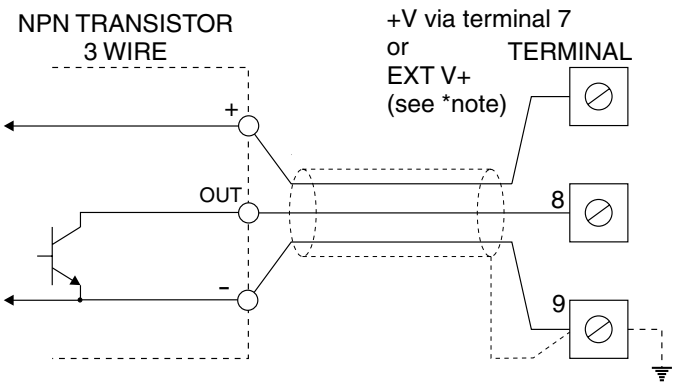

+V via terminal 7  
or  
EXT V+  
(see \*note)

**TERMINAL**

**3 wire NPN transistor sensor**

Typical Internal Link Settings

FREQ	Link LK1	out
BIAS	Link LK2	in
DC	Link LK3	in
HYST	Link LK4	in or out *
HYST2	Link LK5	in or out *
GND	Link LK6	out
LOW FREQ	Link LK7	out
AC	Link LK8	out
VCC	Link LK9	in

\* See "Input link settings, section 3.10".

Note: the transducer may require an external DC supply. This may be provided from a remote power source, by a DC output on terminal 7 or optional isolated DC supply (see "Transducer power supply").

**PNP TRANSISTOR**

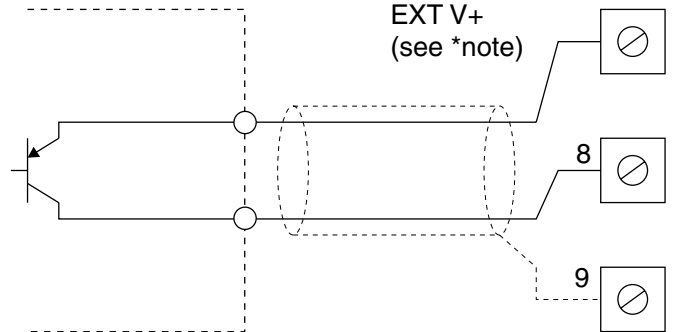

+V via terminal 7  
or  
EXT V+  
(see \*note)

**TERMINAL**

**PNP transistor sensor**

Typical Internal Link Settings

FREQ	Link LK1	out
BIAS	Link LK2	in
DC	Link LK3	in
HYST	Link LK4	in or out *
HYST2	Link LK5	in or out *
GND	Link LK6	out
LOW FREQ	Link LK7	in
AC	Link LK8	out
VCC	Link LK9	out

\* See "Input link settings, section 3.10".

Note: the transducer may require an external DC supply. This may be provided from a remote power source, by a DC output on terminal 7 or optional isolated DC supply (see "Transducer power supply").

**PNP TRANSISTOR 3 WIRE**

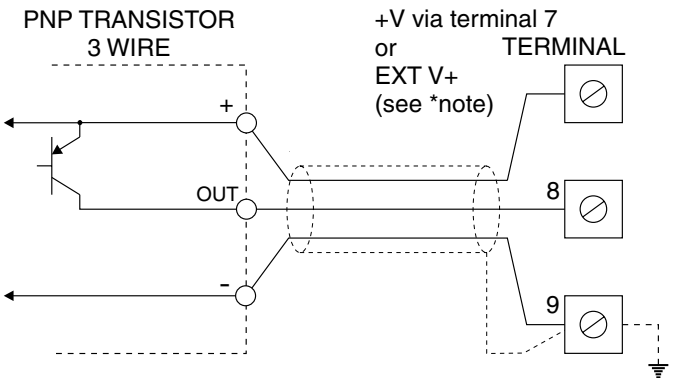

+V via terminal 7  
or  
EXT V+  
(see \*note)

**TERMINAL**

**3 wire PNP transistor sensor**

Typical Internal Link Settings

FREQ	Link LK1	out
BIAS	Link LK2	in
DC	Link LK3	in
HYST	Link LK4	in or out *
HYST2	Link LK5	in or out *
GND	Link LK6	in
LOW FREQ	Link LK7	out
AC	Link LK8	out
VCC	Link LK9	out

\* See "Input link settings, section 3.10".

Note: the transducer may require an external DC supply. This may be provided from a remote power source, by a DC output on terminal 7 or optional isolated DC supply (see "Transducer power supply").

### 3.9 Configuring the input board

Remove the circuit board from the case following the instructions below.

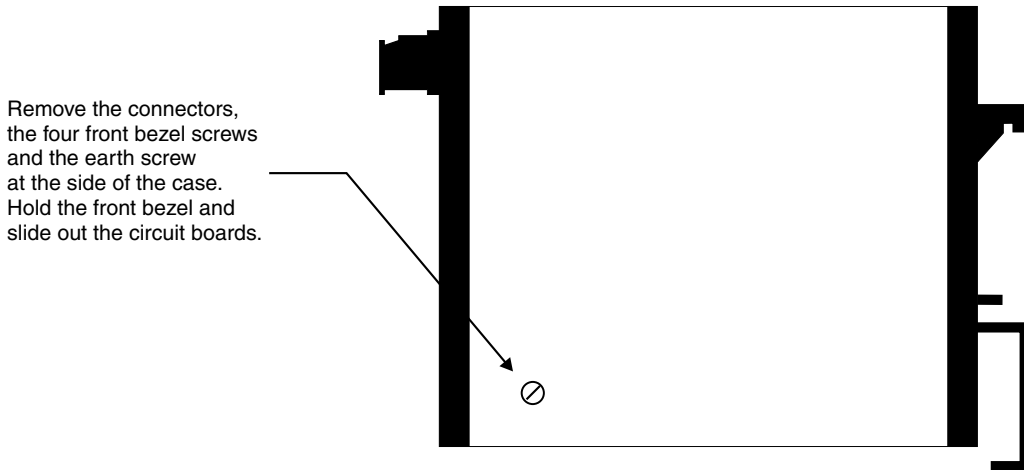

Link settings for the main input boards are as shown below. For optional output link settings consult the appropriate appendix in this manual.

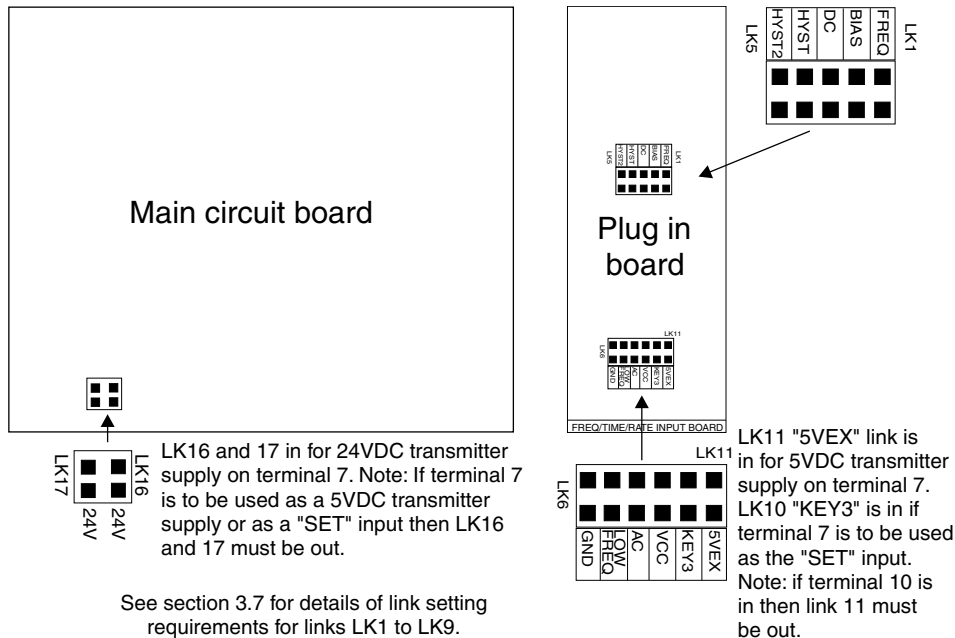

### 3.10 Input link settings

The **AC** link LK8 is only in when the RM4 is to be used to measure the frequency of its own AC supply input, this mode also requires other factory fitted components and is therefore only available when if this mode is specified when ordered. No signal input other than the AC supply is required when this method is used i.e. there is no input to signal fed to terminal 8.

The **LOW FREQ** link LK7 is primarily provided to filter out contact bounce for voltage free inputs. It can also be used to filter out frequencies above approx. 80Hz in electrically noisy environments when the maximum input frequency is less than approx. 80Hz.

The **GND** link LK6 and **VCC** link LK9 should both be out when the input is greater than 24V RMS or 24VDC (48V RMS or 48VDC max. with links removed).

**HYST2** link LK5 should be in for signals greater than 1V. **HYST** link LK4 should be in for signals greater than 5V. For signals lower than 1V both links should be out (100mV minimum signal). A maximum of one hysteresis link should be fitted.

The **DC** coupling link LK3 should be in for frequencies less than 10Hz.

The **BIAS** link LK2 should be in when input signal does not go below 0V.

The **FREQ** link LK1 is used to create a sharply rising edge to give a more definite pulse signal and will be used mainly for input signals with slowly rising edges, typically sinewave AC inputs and inductive inputs.

## 4 Ratemeter explanation of functions

### Ratemeter/Frequency operation

The description of functions in this chapter covers **FREQ** (frequency/rate) functions only. This mode is selected at the set operation (**SET OPER**) function.

Remember that you will need to enter via **CAL** or **FUNC** mode to gain access to functions, the function table for each mode shows which functions require entry via **CAL** mode. See "Introduction" chapter for details of how to enter **FUNC** and **CAL** modes.

### Frequency/rate mode operation modes.

This mode is chosen by selecting **FREQ** at the **SET OPER** function. The ratemeter mode can operate in one of 4 basic ways to give different display options namely:

#### 1. Rate display, high frequency.

If **HI F** is selected at the **FREQ RANGE** function the instrument acts as a general purpose frequency/ratemeter/tachometer. If a very low frequency (below approx. 4Hz) input is used then **LO F** mode should be selected. At frequencies below 4Hz, if **HI F** is selected, the display may alternate between an actual frequency reading and a zero reading, this is due to the higher sampling rate when **HI F** is selected.

Functions specific to display with **FREQ RANGE** set to **HI F** with a rate display

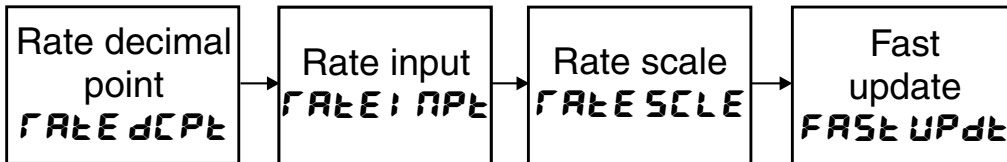

#### 2. Rate display, low frequency.

If **LO F** is selected at the **FREQ RANGE** function the instrument expects an input frequency of less than 1kHz. This mode allows very low frequency inputs without exhibiting the apparent display instability often seen with low frequency inputs. This display stability is accomplished by allowing the user to set a "time out" value - see the **time SECS** function.

Functions specific to display with **FREQ RANGE** set to **LO F** with a rate display

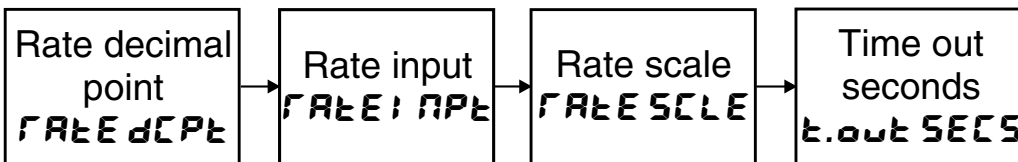

#### 3. Period display, low frequency.

With **LO F** selected at the **FREQ RANGE** function the user has the option of either displaying the rate (**RATE**) or period (**PERd**) of the input (chosen via the **di SP** function). If **PERd** is selected then the display will show the period (or scaled period if required) of the input pulse rather than the rate.

Functions specific to display with **FREQ RANGE** set to **LO F** with a period display

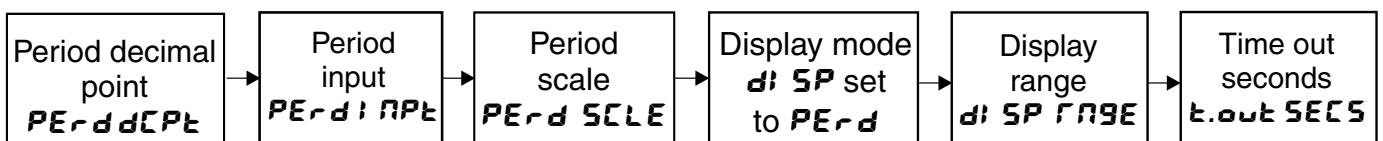

#### 4. Averaged rate display.

With **AUSE** selected at the **FREQ RANGE** function the display will average the rate input over the number of seconds selected at the **AUSE SECS** function. The display will only update at the end of the averaging period. This mode allows the user to see a steady averaged display for an input which produces short term irregularities.

Functions specific to display with **FREQUENCY** set to **AUSE** with an averaged rate display

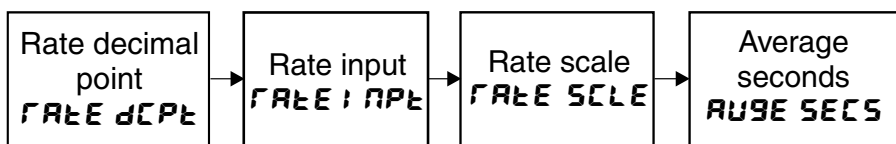

Function	Description
<b>AXLo</b>	Alarm relay low setpoint - see "Alarm relays" chapter. Displays and sets each alarm low setpoint value.
<b>AXH.</b>	Alarm relay high setpoint - see "Alarm relays" chapter. Displays and sets each alarm high setpoint value.
<b>AXHY</b>	Alarm relay hysteresis [deadband] - see "Alarm relays" chapter. Displays and sets the alarm hysteresis limit. This value is common for both high and low setpoint values.
<b>AXt.t</b>	Alarm relay trip time - see "Alarm relays" chapter. Displays and sets the alarm trip time in seconds/tenths of seconds. This value is common for both alarm high and low setpoint values.
<b>AXr.t</b>	Alarm relay reset time - see "Alarm relays" chapter. Displays and sets the alarm reset time in seconds/tenths of seconds. This value is common for both alarm high and low setpoint values.
<b>AXn.o</b> or <b>AXn.c</b>	Alarm relay normally open or normally closed - see "Alarm relays" chapter. Displays and sets the alarm relay action to normally open (de-energised) or normally closed (energised), when no alarm condition is present.
<b>AX.SP,</b> <b>AX.t 1,</b> <b>AX.t 2</b> etc.	Alarm relay operation independent setpoint or trailing - see "Alarm relays" chapter.
<b>brgt</b>	Display brightness - displays and sets the digital display brightness. The display brightness is selectable from <b>1</b> to <b>15</b> where <b>1</b> = lowest intensity and <b>15</b> = highest intensity. This function is useful for reducing glare in darkened areas.
<b>dull</b>	Remote display brightness - displays and sets the level for remote input brightness switching, see "Remote input functions" chapter. See also <b>d.off SECS</b> function below.
<b>d.off SECS</b>	Auto display dimming timer - this function allows a time to be set after which the display brightness (set by the <b>brgt</b> function) will automatically be set to the level set at the <b>dull</b> function. The auto dimming feature can be used to reduce power consumption. The function can be set to any value between <b>0</b> and <b>9999</b> seconds. A setting of <b>0</b> disables the auto dimming. The display brightness can be restored by pressing any of the instruments front push buttons. The display brightness will also be restored whilst one or more alarm relays is activated.
<b>CAL</b> mode functions	
Entry via <b>CAL</b> mode (see "Introduction" chapter) or setting <b>ACCESS</b> function to <b>ALL</b> must be made in order to view and adjust the functions which follow.	

<b>rEE-</b>	<p>Analog recorder/retransmission output low value - seen only when the analog retransmission option is fitted. Refer to the separate “RM4 DIN Rail Meter Optional Output Addendum” booklet supplied when this option is fitted.</p> <p>Displays and sets the analog retransmission output low value (4mA or 0V) in displayed engineering units. e.g. for a 4-20mA retransmission if it is required to retransmit 4mA when the display indicates <b>0</b> then select <b>0</b> at this function via the <b>▲</b> or <b>▼</b> button.</p>
<b>rEE+</b>	<p>Analog recorder/retransmission output high value - seen only when the analog retransmission option is fitted. Refer to the separate “RM4 DIN Rail Meter Optional Output Addendum” booklet supplied when this option is fitted.</p> <p>Displays and sets the analog retransmission output high value (20mA, 1V or 10V) in displayed engineering units. e.g. if it is required to retransmit 20mA when the display indicates <b>500</b> then select <b>500</b> at this function via the <b>▲</b> or <b>▼</b> button.</p>
<b>rEE- Ch 2</b>	<p>Second analog recorder/retransmission output low value - seen only when the dual analog retransmission option is fitted. See <b>rEE-</b> function for description of operation. Refer to the separate “RM4 DIN Rail Meter Optional Output Addendum” booklet supplied when this option is fitted.</p>
<b>rEE+ Ch 2</b>	<p>Second analog recorder/retransmission output high value - seen only when the dual analog retransmission option is fitted. See <b>rEE+</b> function for description of operation. Refer to the separate “RM4 DIN Rail Meter Optional Output Addendum” booklet supplied when this option is fitted.</p>
<b>drnd</b>	<p>Display rounding - displays and sets the display rounding value. This value may be set to <b>0 - 5000</b> displayed units. Display rounding is useful for reducing the instrument resolution without loss of accuracy in applications where it is undesirable to display to a fine tolerance (example: if set to <b>10</b> the instrument will display only in multiples of 10).</p>
<b>FLtr</b>	<p>Digital filter - displays and sets the digital filter value. Digital filtering is used for reducing susceptibility to short term interference. The digital filter range is selectable from <b>0</b> to <b>8</b>, where <b>0</b> = none and <b>8</b> = most filtering. A typical value for the digital filter would be <b>3</b>. The digital filter uses a weighted averaging method of filtering which will increase the display update time at higher settings.</p>
<b>rALE dCPE</b>	<p>Rate decimal point selection - displays and sets the decimal point position for the rate display. For example selecting <b>0</b> will mean no decimal points (e.g. a display such as <b>25</b>), <b>0.1</b> means 1 decimal point place (e.g. <b>25.4</b>), <b>0.02</b> gives 2 decimal point places (e.g. <b>25.35</b>) etc.</p> <p>Note: If the number of decimal points is altered then the display scaling figure (<b>rALE SCALE</b>) will also be affected. Always check the scaling figure following a decimal point change and alter as required.</p>
<b>PERd dCPE</b>	<p>Period decimal point selection (only seen when period display selected) - displays and sets the decimal point for the period display. Note that the decimal point display is tied to the display range (<b>dI SP RANGE</b>) function e.g. if the display range function is set to <b>0.00.02</b> then the two decimal place setting will show up as <b>0.00.02</b> and one decimal place will show as <b>0.00.1</b>.</p>
<b>rALE iNPE</b>	<p>Rate input scale factor - displays and sets the number of input pulses to be used with the rate scale function to generate the display scaling. See examples later in this chapter.</p>
<b>rALE SCALE</b>	<p>Rate scale factor - displays and sets the scale factor to be used with the rate input setting. See examples later in this chapter. Scale and input work together as follows:</p> $\text{Display} = \frac{\text{Input frequency (Hz)} \times \text{rALE SCALE}}{\text{rALE iNPE}}$
<b>PERd iNPE</b>	<p>Period input scale factor - displays and sets the period value to be used with the period scale function value to generate the period display scaling. See examples later in this chapter and the formula below.</p>

<b>PERd SCALE</b>	<p>Period scale factor (only seen when period display selected) - displays and sets the scale factor to be used with the period input setting. To calculate the display value the input frequency and hence the period of this input needs to be known. Scale and input work together to produce a display as follows:</p> $\text{Display} = \frac{\text{Input period (milli seconds)} \times \text{PERd SCALE}}{\text{PERd: RATE}}$ <p>Note: the displayed value is also affected by the decimal point and display range settings.</p>
<b>FREQ RNGE</b>	<p>Frequency range - displays and sets the frequency input range. Select <b>LOF</b> if the input frequency is likely to be lower than 4Hz and not greater than 1kHz. Select <b>H, F</b> for frequencies with a minimum input frequency of 3Hz or higher (maximum input frequency is 100kHz).</p> <p>Note that the period display (in <b>both</b> or <b>FREQ</b> modes) will only be accessible when the frequency range is set to <b>LOF</b> and hence the input frequency must not be above 1kHz.</p> <p>Select <b>AUSE</b> for an averaged display. The averaged display allows the input rate to be averaged over a period of seconds set by the <b>AUSE SECS</b> function. An averaged display is particularly useful when the input is irregular. By averaging the pulses over a period of time the display will give a more stable reading for these irregular inputs.</p>
<b>FAST UPdt</b>	<p>Fast update (seen only when <b>FREQ RNGE</b> set to <b>H, F</b>) - with <b>FAST UPdt</b> set to <b>OFF</b> the relay and analog retransmission updates will take place approximately twice per second. With <b>FAST UPdt</b> set to <b>on</b> the relay and analog retransmission updates will take place approximately six times per second.</p>
<b>: RATE EDGE</b>	<p>Input edge triggering - displays and sets the input edge on which the instrument will trigger. Select <b>FALL</b> for triggering on a falling edge. Select <b>RISE</b> for triggering on a rising edge.</p>
<b>di SP</b>	<p>Period or rate display - when using the low frequency range the user has the option of displaying either the rate of the input or the period of the input. Select <b>FARE</b> for a rate display in Hz. Select <b>PERd</b> for a period display (display format is determined by the display range function (<b>di SP RNGE</b>) and the decimal point setting).</p>

<p><b>d: SP RANGE</b></p>	<p>Period display range - Sets the display range when <b>PERd</b> is chosen as the default display at the <b>d: SP</b> function (<b>FREQ RANGE</b> must also be set to <b>LoF</b> to see this function). The options are <b>0.0.0</b> or <b>0.00.02</b>.</p> <p>The <b>0</b> option allows a display in milli seconds. The <b>0.0</b> option allows a display in minutes and seconds and the <b>0.00.02</b> option allows a display in hours.mins.secs.</p> <p>The display units and scaling will now depend on the <b>PERd dCPE</b>, <b>PERd: NPt</b> and <b>PERd SCL</b> settings e.g. the display can be scaled to give a reading which is ten times the real period if required.</p> <p>Examples below show how a 2Hz input (0.5 sec or 500mS period) is affected by the <b>d: SP RANGE</b>, <b>PERd dCPE</b> and <b>PERd SCL</b> functions. Examples are shown for a 5 digit display type instrument.</p> <table border="1" data-bbox="347 510 1353 884"> <thead> <tr> <th><b>d: SP RANGE</b></th> <th><b>PERd dCPE</b></th> <th><b>PERd: NPt</b></th> <th><b>PERd SCL</b></th> <th>Value displayed</th> </tr> </thead> <tbody> <tr> <td><b>0</b></td> <td><b>0</b></td> <td><b>1</b></td> <td><b>1</b></td> <td><b>500</b></td> </tr> <tr> <td><b>0</b></td> <td><b>0</b></td> <td><b>1</b></td> <td><b>2</b></td> <td><b>1000</b></td> </tr> <tr> <td><b>0</b></td> <td><b>0</b></td> <td><b>1</b></td> <td><b>10</b></td> <td><b>5000</b></td> </tr> <tr> <td><b>0</b></td> <td><b>0.003</b></td> <td><b>1</b></td> <td><b>0.00 1</b></td> <td><b>0.500</b></td> </tr> <tr> <td><b>0.0 1</b></td> <td><b>0.00</b></td> <td><b>1</b></td> <td><b>1.00</b></td> <td><b>500.0</b></td> </tr> <tr> <td><b>0.00.02</b></td> <td><b>0.00.02</b></td> <td><b>1</b></td> <td><b>0.00.0 1</b></td> <td><b>0.05.00</b></td> </tr> <tr> <td><b>0.00.02</b></td> <td><b>0.00.02</b></td> <td><b>1</b></td> <td><b>0.0 1.00</b></td> <td><b>5.00.00</b></td> </tr> </tbody> </table> <p>With the <b>PERd: NPt</b> function set to 1000 the display will time in seconds rather than milli seconds. The display can now be made to show hours minutes &amp; seconds. The table below gives some examples.</p> <table border="1" data-bbox="347 996 1401 1149"> <thead> <tr> <th><b>d: SP RANGE</b></th> <th><b>PERd dCPE</b></th> <th><b>PERd: NPt</b></th> <th><b>PERd SCL</b></th> <th>Actual period</th> <th>Value displayed</th> </tr> </thead> <tbody> <tr> <td><b>0.00.02</b></td> <td><b>0.00.02</b></td> <td><b>1000</b></td> <td><b>0.00.0 1</b></td> <td>1m15s</td> <td><b>0.0 1.15</b></td> </tr> <tr> <td><b>0.00.02</b></td> <td><b>0.00.02</b></td> <td><b>1000</b></td> <td><b>0.00.0 1</b></td> <td>2h12m30s</td> <td><b>2. 12.30</b></td> </tr> </tbody> </table>	<b>d: SP RANGE</b>	<b>PERd dCPE</b>	<b>PERd: NPt</b>	<b>PERd SCL</b>	Value displayed	<b>0</b>	<b>0</b>	<b>1</b>	<b>1</b>	<b>500</b>	<b>0</b>	<b>0</b>	<b>1</b>	<b>2</b>	<b>1000</b>	<b>0</b>	<b>0</b>	<b>1</b>	<b>10</b>	<b>5000</b>	<b>0</b>	<b>0.003</b>	<b>1</b>	<b>0.00 1</b>	<b>0.500</b>	<b>0.0 1</b>	<b>0.00</b>	<b>1</b>	<b>1.00</b>	<b>500.0</b>	<b>0.00.02</b>	<b>0.00.02</b>	<b>1</b>	<b>0.00.0 1</b>	<b>0.05.00</b>	<b>0.00.02</b>	<b>0.00.02</b>	<b>1</b>	<b>0.0 1.00</b>	<b>5.00.00</b>	<b>d: SP RANGE</b>	<b>PERd dCPE</b>	<b>PERd: NPt</b>	<b>PERd SCL</b>	Actual period	Value displayed	<b>0.00.02</b>	<b>0.00.02</b>	<b>1000</b>	<b>0.00.0 1</b>	1m15s	<b>0.0 1.15</b>	<b>0.00.02</b>	<b>0.00.02</b>	<b>1000</b>	<b>0.00.0 1</b>	2h12m30s	<b>2. 12.30</b>
<b>d: SP RANGE</b>	<b>PERd dCPE</b>	<b>PERd: NPt</b>	<b>PERd SCL</b>	Value displayed																																																							
<b>0</b>	<b>0</b>	<b>1</b>	<b>1</b>	<b>500</b>																																																							
<b>0</b>	<b>0</b>	<b>1</b>	<b>2</b>	<b>1000</b>																																																							
<b>0</b>	<b>0</b>	<b>1</b>	<b>10</b>	<b>5000</b>																																																							
<b>0</b>	<b>0.003</b>	<b>1</b>	<b>0.00 1</b>	<b>0.500</b>																																																							
<b>0.0 1</b>	<b>0.00</b>	<b>1</b>	<b>1.00</b>	<b>500.0</b>																																																							
<b>0.00.02</b>	<b>0.00.02</b>	<b>1</b>	<b>0.00.0 1</b>	<b>0.05.00</b>																																																							
<b>0.00.02</b>	<b>0.00.02</b>	<b>1</b>	<b>0.0 1.00</b>	<b>5.00.00</b>																																																							
<b>d: SP RANGE</b>	<b>PERd dCPE</b>	<b>PERd: NPt</b>	<b>PERd SCL</b>	Actual period	Value displayed																																																						
<b>0.00.02</b>	<b>0.00.02</b>	<b>1000</b>	<b>0.00.0 1</b>	1m15s	<b>0.0 1.15</b>																																																						
<b>0.00.02</b>	<b>0.00.02</b>	<b>1000</b>	<b>0.00.0 1</b>	2h12m30s	<b>2. 12.30</b>																																																						
<p><b>t.out SECS</b></p>	<p>Time out (only seen if <b>LoF</b> is selected under the <b>FREQ RANGE</b> function) - displays and sets the time out in seconds when using the low frequency (<b>LoF</b>) range. The timeout allows very low frequency inputs to be used without the display reverting to zero between samples. If no input pulses are received the display hold the previous display value for the time out period. If a pulse is received during this time the display will update. If no pulses are received or the input period exceeds the time out value set then the display will indicate <b>0</b> (or <b>-or-</b> if displaying period). The allowable time out range is 1 to 9999 seconds.</p>																																																										
<p><b>AUSE SECS</b></p>	<p>Average seconds (only seen if <b>AUSE</b> is selected under the <b>FREQ RANGE</b> function) - displays and sets the number of seconds over which the rate should be averaged when using the low frequency (<b>LoF</b>) range. The rate display will not update until the end of the average seconds time. This function allows the user to select a display update rate most suitable for applications in which the rate input may be irregular. The allowable averaging range is 1 to 9999 seconds.</p>																																																										

<p><b>F.I NP</b></p>	<p>Remote input function - terminals 5 and 9 are the remote input pins. When these pins are short circuited, via a pushbutton or keyswitch the instrument will perform the selected remote input function. A message will flash to indicate which function has been selected when the remote input pins are short circuited. The remote input functions are as follows:</p> <p><b>NONE</b> - no remote function required</p> <p><b>P.HLd</b> - peak hold. The display will show the peak hold value whilst the remote input pins are short circuited</p> <p><b>d.HLd</b> - display hold. The display will hold its value whilst the remote input pins are short circuited</p> <p><b>H<sub>i</sub></b> - peak memory. The peak value stored in memory will be displayed if the remote input pins are short circuited, if the short circuit is momentary then the display will return to normal measurement after 20 seconds. If the short circuit is held for 1 to 2 seconds then the memory will be cleared</p> <p><b>L<sub>o</sub></b> - valley memory. The minimum value stored in memory will be displayed. Otherwise operates in the same manner as the <b>H<sub>i</sub></b> function</p> <p><b>H<sub>i</sub> L<sub>o</sub></b> - toggle between <b>H<sub>i</sub></b> and <b>L<sub>o</sub></b> displays. This function allows the remote input to be used to toggle between peak and valley memory displays. The first operation of the remote input will cause the peak memory value to be displayed, the next operation will give a valley memory display. <b>PH<sub>i</sub></b> or <b>PL<sub>o</sub></b> will flash before each display to give an indication of display type</p> <p><b>ZEFO</b> - zero the display. The total will be zeroed when the remote input is short circuited</p> <p><b>SP.AC</b> - setpoint access only. This blocks access to any functions except the alarm setpoint functions unless the remote input pins are short circuited or entry is made via <b>CAL</b> mode</p> <p><b>No.AC</b> - no access. This blocks access to all functions unless the remote input pins are short circuited or entry is made via <b>CAL</b> mode</p> <p><b>d: SP</b> - display toggle. This function will cause the display to toggle from the default display to the alternate display when the remote input pins are short circuited</p> <p><b>dULL</b> - display brightness control. The remote input can be used to change the display brightness. When this mode is selected the display brightness can be switched, via the remote input, between the brightness level set at the <b>br 9t</b> function and the brightness level set at the <b>dULL</b> function</p> <p><b>9.r 5t</b> - grand total reset. This mode allows the remote input to be used as a reset input for the grand total seen in the <b>tob<sub>i</sub></b> and <b>both</b> modes</p>
<p><b>P.but</b></p>	<p><b>P</b> button function - The front <b>P</b> button may be set to operate one chosen special function. With some functions, to prevent accidental operation, the <b>P</b> button must be held pressed for 2-3 seconds before the function will operate. If both the remote input and <b>P</b> button function are operated simultaneously the <b>P</b> button will override the remote input.</p> <p>The available functions, except for <b>FUNC</b>, are as described in the <b>F.I NP</b> function above.</p> <p>Functions available are: <b>NONE</b>, <b>H<sub>i</sub></b>, <b>L<sub>o</sub></b>, <b>H<sub>i</sub> L<sub>o</sub></b>, <b>ZEFO</b>, <b>d: SP</b>, <b>FUNC</b> or <b>9r 5t</b>.</p> <p>The <b>FUNC</b> function is used only in totalising and can be used to adjust the preset value. When set to <b>FUNC</b> the message <b>PSEt</b> will appear when the <b>P</b> button is pressed. The operator can then adjust the preset via the <b>▲</b> or <b>▼</b> button, <b>F</b> is then pressed to accept the change. A message <b>End</b> will be seen when the new preset value is accepted.</p> <p>The <b>ZEFO</b>, <b>FUNC</b> and <b>9r 5t</b> functions are applicable only to totaliser operation.</p>
<p><b>ACCS</b></p>	<p>Access mode - the access mode function <b>ACCS</b> has four possible settings namely <b>OFF</b>, <b>EASY</b>, <b>NONE</b> and <b>ALL</b>. If set to <b>OFF</b> the mode function has no effect on alarm relay operation. If set to <b>EASY</b> the easy alarm access mode will be activated, see details below. If set to <b>NONE</b> there will be no access to any functions via <b>FUNC</b> mode, entry via <b>CAL</b> mode must be made to gain access to alarm functions. If set to <b>ALL</b> then entry to all functions can be made via <b>FUNC</b> mode i.e. <b>CAL</b> mode entry is not required. Alarm relay and function access mode - see "Alarm relays" chapter.</p>

<b>SPAC</b>	Setpoint access - sets the <b>FUNC</b> mode access to the alarm relays set points. The following choices are available; <b>A 1</b> - Allows setpoint access to alarm 1 only. <b>A 1-2</b> - Allows access to alarms 1 and 2 only. <b>A 1-3</b> - Allows access to alarms 1, 2 and 3 only etc. up to the maximum number of relays fitted. To allow this function to operate the remote input <b>F.I; RP</b> function must be set to <b>SPAC</b> .
<b>c.rSt</b>	Counter reset value - not applicable to ratemeter operation.
<b>c.rSt</b>	Counter reset mode - not applicable to ratemeter operation.
<b>SEt OPER</b>	Set operating mode - displays and sets the selected operating mode, e.g. select <b>totl</b> for totaliser operation. See the dedicated chapter in this manual for description of the required operating mode. Options are: <b>S.Pr d</b> - Not applicable to this manual <b>PEFd</b> - Not applicable to this manual <b>both</b> - Frequency and total measurement - allows toggling between rate and total display. <b>totl</b> - Total measurement <b>FFEQ</b> - Frequency/rate measurement
<b>baud</b>	Set baud rate - seen only with serial output option - Refer to the separate "RM4 DIN Rail Meter Optional Output Addendum" booklet supplied when this option is fitted. Select from <b>300 . 600 . 1200 . 2400 . 4800 . 9600 . 19.2</b> or <b>38.4</b> .
<b>Prty</b>	Set parity - seen only with serial output option - Refer to the separate "RM4 DIN Rail Meter Optional Output Addendum" booklet supplied when this option is fitted. Select parity check to either <b>NONE</b> , <b>EVEN</b> or <b>odd</b> .
<b>O.PuL</b>	Set RS232/485 interface mode - seen only with serial output option. Refer to the separate "RM4 DIN Rail Meter Optional Output Addendum" booklet supplied when this option is fitted. Select <b>d</b> , <b>SP</b> , <b>Cont</b> or <b>POLL</b> Allows user to select the RS232/485 interface operation as follows:- <b>d, SP</b> Sends image data from the display without conversion to ASCII. <b>Cont</b> Sends ASCII form of display data every time display is updated. <b>POLL</b> Controlled by computer or PLC as host. Host sends command via RS232/485 and instrument responds as required. <b>ā.bus</b> Modbus RTU communications <b>R.bus</b> This mode is used only when the RM4 is connected to a computer running the optional Windows compatible live data and logging software. Refer to the user manual supplied with this software. Allows live viewing and logging to disk of of rate/total & grand total.
<b>Addr</b>	Set unit address for polled ( <b>POLL</b> ) mode (0 to 31)) Refer to the separate "RM4 DIN Rail Meter Optional Output Addendum" booklet supplied when this option is fitted. Allows several units to operate on the same RS485 interface reporting on different areas etc. The host computer or PLC may poll each unit in turn supplying the appropriate address. The unit address ranges from 0 to 31 (DEC) but is offset by 32 (DEC) to avoid clashing with ASCII special function characters (such as <STX> and <CR>). Therefore 32 (DEC) or 20 (HEX) is address 0, 42 (DEC) or 2A (HEX) addresses unit 10.

### Returning to the normal measure mode

When the calibration procedure has been completed it is advisable to return the instrument to the normal mode (where calibration functions cannot be tampered with). To return to the normal mode, turn off power to the instrument, wait a few seconds and then restore power.

## 4.1 Examples

### Rate display examples

The rate input factor must always be a whole number but the rate scale factor may have decimal points if decimal points are used in the display. The formula for the rate display is:

$$\text{Display} = \frac{\text{Input frequency (Hz)} \times \text{RATE SCALE}}{\text{RATE INPT}}$$

#### Example - Low frequency input rate display

A transducer is being used to give one pulse out for every bottle passing a point on a track. The display is required to show bottles per minute. The number of bottles passing can be as low as one every five seconds up to two per second. No decimal points or alarm functions are required. The **RATE INPT** value will be 1 and the **RATE SCALE** value will be 60 i.e. 1 bottle per second = 60 bottles per minute. The procedure is as follows:

1. Enter the setup functions via **CAL** mode.
2. Step through the functions by pressing and releasing **F** until the **RATE INPT** function is seen.
3. Use the **▲** or **▼** push button to change the setting to **1**.
4. Press **F**, the function **RATE SCALE** will appear followed by the previous input value.
5. Use the **▲** or **▼** push button to change the setting to **60**.
6. Press **F**, the function **FEQ FREQ** will appear followed by the previous setting.
7. Use the **▲** or **▼** push button to change the setting to **LOF**.
8. Step through the functions by pressing and releasing **F** until the **LOUT SECS** function is seen.
9. Use the **▲** or **▼** push button to change the setting to a value greater than 5 seconds e.g. **8**.
10. Press **F** to accept the change then either press **P** to exit or continue pressing and releasing **F** until the **FUNC End** message is seen and the unit returns to normal measure mode.

#### Example - Low frequency input averaged rate display

In applications similar to the bottles/minute one above where the input rate is irregular it is sometimes preferable to show an averaged rate display. The averaged display will update at the end of the averaged period, set at the **AUSE SECS** function and will therefore show less short term variation in the rate figure. To use the average mode the **FEQ FREQ** function must be set to **AUSE**.

#### Example - RPM display

A proximity sensor connected to a flywheel produces 20 pulses per revolution. The RM4 is required to display in RPM with 1 decimal point place.

The standard setpoint relay is required to close if the RPM figure falls below 518.5 or goes above 600.0 with a hysteresis of 20.0 RPM. Note that the first setting which needs to be altered is the decimal point position. The alarm settings will therefore come after the other settings in this example.

In this example 20 pulses per second would equal 1 revolution /sec which equals 60 RPM. The **LOUT INPT** figure and **LOUT SCALE** figure could be 20 and 60.0 respectively but we will use 1 and 3.0 since they give the same ratio and hence will give the same reading on the display.

1. Follow the procedure shown on page 3 to enter the setup functions via **CAL** mode.
2. Step through the functions by pressing and releasing **F** until the **RATE dCPT** function is seen.
3. Use the **▲** or **▼** push button to change the setting to **0. 1**.
4. Press **F**, the function **RATE INPT** will appear followed by the previous input value.
5. Use the **▲** or **▼** push button to alter the previous input value to the new input value of **1**.
6. Press **F**, the function **RATE SCALE** will appear followed by the previous scale value.
7. Use the **▲** or **▼** push button to alter the previous scale value to the new scale value of **3.0**.
8. Press **F** to accept the change then either press **P** to exit or continue pressing and releasing **F** until the **FUNC End** message is seen and the unit returns to normal measure mode.
9. Follow the procedure shown on page 3 to enter the setup functions via **FUNC** mode.
10. The first function is **R !Lo** this will be seen followed by the previous low alarm setting.
11. Use the **▲** or **▼** push button to change the **R !Lo** setting to **5 !8.5**. Press **F** to accept the change.
12. Press **F**, the function **R !H** will appear followed by the setpoint value.
13. Use the **▲** or **▼** push button to alter the previous setpoint value to the new setpoint value of

600.0.

14. Press **F**, the function **R HY** will appear followed by the previous hysteresis value.
15. Use the **▲** or **▼** push button to alter the previous hysteresis value to the new hysteresis value of 20.0.
16. Step through the functions by pressing and releasing **F** until the **R In.o/R In.c** function is seen.
17. Use the **▲** or **▼** push button to change the setting to **R In.o** (normally open operation).
18. Press **F** to accept the change then either press **P** to exit or continue pressing and releasing **F** until the **FUNC End** message is seen and the unit returns to normal measure mode.

**Example - Flow rate display**

See previous examples for detailed steps showing how to alter functions. Flowmeters produce an output frequency proportional to the rate of flow the scaling is calculated using information provided by the manufacturer or from test results. e.g.:

A turbine produces 767 pulses per litre

- to display litres/second set **FAEE: NPL** to 767 and **FAEE SCALE** to 1.
- to display litres/minute set **FAEE: NPL** to 767 and **FAEE SCALE** to 60.
- to display litres/hour set **FAEE: NPL** to 767 and **FAEE SCALE** to 3600.
- to display kilolitres/hour set **FAEE: NPL** to 7670 and **FAEE SCALE** to 36.

**Example - Flow rate display from a Rota pulse flowmeter**

In some applications the number of pulses per litre is not known but the number of pulses per metre flow of liquid is given. The number of pulses per litre would then be calculated from the area of the pipe being used. The example below shows how scaling factors can be calculated for this type of application. See also the “Totaliser Explanation of Functions” chapter for examples of total scaling for such a flowmeter.

The “Rota pulse” paddle wheel flow meter (this sensor model is commonly used as an input to the PM4-TR) outputs approx. 36.5 pulses per metre flow of liquid in a pipe. In this example we will assume that the pipe internal diameter is 50mm (25mm or 0.025m radius).

The steps to calculate the scaling of the meter for this example are as follows:

1. Calculate the area of the pipe in square metres:  
 $Area = \pi \times r^2 = \pi \times 0.025^2 = 0.00196m^2$
2. Calculate the volume of a 1m length of pipe:  
 $Volume = Area \times length = 0.00196 \times 1 = 0.00196m^3$
3. For every 36.5 pulses we therefore have 0.00196 cubic metres of liquid or 1.96 litres of liquid (there are 1000 litres in one cubic metre). For a litres/sec display we could therefore have scaling factors of **FAEE: NPL** = 3650 and **FAEE SCALE** = 196.

The table below shows typical scaling factors for this flowmeter.

Table for Rota pulse flowmeter with 36.5 pulses per metre flow.				
Pipe internal dia.	Ratometer scaling factors.			
	Litres/second	Litres/minute	Litres/hour	m <sup>3</sup> /hour
25mm	<b>FAEE: NPL</b> = 3650 <b>FAEE SCALE</b> = 49	<b>FAEE: NPL</b> = 365 <b>FAEE SCALE</b> = 295	<b>FAEE: NPL</b> = 365 <b>FAEE SCALE</b> = 17640	<b>FAEE: NPL</b> = 36500 <b>FAEE SCALE</b> = 1764
40mm	<b>FAEE: NPL</b> = 3650 <b>FAEE SCALE</b> = 126	<b>FAEE: NPL</b> = 365 <b>FAEE SCALE</b> = 756	<b>FAEE: NPL</b> = 365 <b>FAEE SCALE</b> = 45360	<b>FAEE: NPL</b> = 365 <b>FAEE SCALE</b> = 45
50mm	<b>FAEE: NPL</b> = 3650 <b>FAEE SCALE</b> = 196	<b>FAEE: NPL</b> = 365 <b>FAEE SCALE</b> = 1176	<b>FAEE: NPL</b> = 365 <b>FAEE SCALE</b> = 70560	<b>FAEE: NPL</b> = 365 <b>FAEE SCALE</b> = 71
80mm	<b>FAEE: NPL</b> = 3650 <b>FAEE SCALE</b> = 503	<b>FAEE: NPL</b> = 365 <b>FAEE SCALE</b> = 3018	<b>FAEE: NPL</b> = 365 <b>FAEE SCALE</b> = 181080	<b>FAEE: NPL</b> = 365 <b>FAEE SCALE</b> = 181
100mm	<b>FAEE: NPL</b> = 3650 <b>FAEE SCALE</b> = 785	<b>FAEE: NPL</b> = 365 <b>FAEE SCALE</b> = 4710	<b>FAEE: NPL</b> = 365 <b>FAEE SCALE</b> = 282600	<b>FAEE: NPL</b> = 365 <b>FAEE SCALE</b> = 281
150mm	<b>FAEE: NPL</b> = 365 <b>FAEE SCALE</b> = 177	<b>FAEE: NPL</b> = 365 <b>FAEE SCALE</b> = 10620	<b>FAEE: NPL</b> = 365 <b>FAEE SCALE</b> = 637200	<b>FAEE: NPL</b> = 365 <b>FAEE SCALE</b> = 637

Note that the above examples can be reduced to smaller numbers as long as the ratio between the two numbers are the same. The scaling factors above are approximate and will vary depending on pipe size and installation conditions. A calibration should be carried out to determine the correct scaling for any installation where accuracy is required.

**Example** - period display in rate mode.

If **L o F** is selected at the **F F E 9 F N 9 E** function then there is an option to display either the period or frequency of the incoming pulses. At the **d i S P** function select the **P E F d** option to display period.

For example a display showing seconds to two decimal places (seconds and hundredths of seconds) is required for the input. The settings required for this display are:

1. **P E F d d C P t** set to **0.02**
2. **P E F d i N P t** set to **1000** (one thousand milli seconds i.e. 1 second)
3. **P E F d S C L E** set to **1.00** i.e. every one thousand milli seconds will cause a display of **1.00**.
4. **F F E 9 F N 9 E** set to **L o F**.
5. **d i S P** set to **P E F d**.
6. **d i S P F N 9 E** set to **0**.
7. **t.o.u.t S E C S** set to a value higher than the lowest input period e.g. if the lowest input period is going to be 10 seconds the **t.o.u.t S E C S** function could be set to 15 seconds.

In the example above the display could be changed to show minutes, seconds & hundredths of seconds by changing the **d i S P F N 9 E** function to **0.0 1**.

**Example** - wind speed display in rate mode.

Model WS30 wind speed sensor sends 1250 pulses per kilometer.

To display in kilometers per hour the settings required are:

**P E F d i N P t** = 125  
**P E F d S C L E** = 360

To display in metres per second:

**P E F d i N P t** = 125  
**P E F d S C L E** = 100

Model WS03002 wind speed sensor outputs a sine wave with 30Hz being equivalent to 22.8m/S or 82km/h.

To display in metres per second:

**P E F d i N P t** = 300  
**P E F d S C L E** = 228

To display in kilometres per hour:

**P E F d i N P t** = 30  
**P E F d S C L E** = 82

## 4.2 Error Messages

" - o r - " - This display indicates an overrange reading. This means that the instrument is not being able to display the number because it is too large i.e. above **99999** . Check that the calibration scaling figures are correct, if viewing total the total will need to be reset.

Display fluctuates between a display of zero and another value. This indicates that the sample rate is faster than the input frequency. See **t.o.u.t S E C S** function.

## 5 Ratemeter Function Table

Initial display	Meaning of display	Next display	Default Setting	Record Your Settings
<i>RxLo</i>	Alarm low setpoint value	Setpoint value or <i>OFF</i>	<i>OFF</i>	See following table
<i>RxHi</i>	Alarm high setpoint value	Setpoint value or <i>OFF</i>	<i>OFF</i>	See following table
<i>RxHY</i>	Alarm hysteresis	Hysteresis value in measured units.	<i>10</i>	See following table
<i>RxTt</i>	Alarm trip time	No of seconds before relay trips	<i>0</i>	See following table
<i>Rxrt</i>	Alarm reset time	No of seconds before relay resets	<i>0</i>	See following table
<i>Rxn.o</i> or <i>Rxn.c</i>	Alarm action N/O or N/C	<i>Rxn.o</i> or <i>Rxn.c</i>	<i>Rxn.o</i>	See following table
<i>RxSP</i> or <i>Rxt!</i>	Setpoint or trailing alarm	<i>RxSP</i> or <i>Rxt!</i>	<i>RxSP</i>	See following table
<i>brgt</i>	Digital display brightness	<i>1</i> to <i>15</i> (15 = highest brightness)	<i>15</i>	
<i>dull</i>	Remote input brightness control	<i>0</i> to <i>15</i> (15 = highest brightness)	<i>0</i>	
<i>d.off SECS</i>	Display auto dimming timer (seconds)	<i>0</i> to <i>9999</i>	<i>0</i>	
Functions below are accessible via <b>CAL</b> mode only.				
<i>FEC-</i>	Analog retransmission low value	Value in memory	<i>0</i>	
<i>FEC+</i>	Analog retransmission high value	Value in memory	<i>1000</i>	
<i>rEC- Ch2</i>	Analog retransmission 2 low value	Value in memory	<i>0</i>	
<i>rEC+ Ch2</i>	Analog retransmission 2 high value	Value in memory	<i>1000</i>	
<i>drnd</i>	Display rounding selects resolution	Value in memory	<i>1</i>	
<i>FLtr</i>	Digital filter range 0 to 8	<i>0</i> to <i>8</i> ( <b>8</b> = most filtering)	<i>2</i>	
<i>rRtEdCPE</i> or <i>PERdCPE</i>	Decimal point setting for rate display or decimal point setting for period depending upon the <i>d: SP</i> setting	Value in memory	<i>0</i>	
<i>rRtE: NPE</i> or <i>PERd: NPE</i>	Rate input setting (Hz) or Period input setting (Secs.) depending upon the <i>d: SP</i> setting	Value in memory	<i>1</i>	
<i>rRtESCLE</i> or <i>PERdSCLE</i>	Rate scale setting or Period scale setting depending upon the <i>d: SP</i> setting	Value in memory	<i>1</i>	
<i>FFEQFN9E</i>	Frequency range low or high or averaged frequency	<i>LoF, HiF</i> or <i>AUSE</i>	<i>H, F</i>	
<i>FRStUPdt</i>	Fast update mode	<i>on</i> or <i>OFF</i>	<i>OFF</i>	
<i>iNPEEd9E</i>	Input edge triggering rising or falling edge	<i>FALL</i> or <i>RISE</i>	<i>RISE</i>	
<i>d: SP</i>	Default display for low frequency input (seen only when <i>FFEQFN9E</i> set to <i>LoF</i> )	<i>rRtE</i> or <i>PERd</i>	<i>rRtE</i>	
<i>d: SPFN9E</i>	Display range (seen only when <i>d: SP</i> set to <i>PERd</i> )	<i>0.0.0 1</i> or <i>0.00.02</i>	<i>0</i>	
<i>t.out SECS</i>	Timeout (seen only when <i>FFEQFN9E</i> set to <i>AUSE</i> or <i>LoF</i> )	Value in memory.	<i>0</i>	
<i>AUSE SECS</i>	Averaging time (seen only when <i>FFEQFN9E</i> set to <i>AUSE</i> )	Value in memory.	<i>0</i>	
<i>r: NP</i>	Remote input	<i>NONE, P.HLd, d.HLd, Hi, Lo, Hi, Lo, ZEG0, SP.Rc, No.Rc, d: SP, dull</i> or <i>grSt</i>	<i>NONE</i>	
<i>P.but</i>	 button operation	<i>NONE, Hi, Lo, Hi, Lo, ZEG0, d: SP, FUNC</i> or <i>grSt</i>	<i>NONE</i>	
<i>RECS</i>	Alarm relay access mode	<i>OFF, EASY, NONE</i> or <i>ALL</i>	<i>OFF</i>	
<i>SPAC</i>	Setpoint access	<i>R 1, R 1-2</i> etc.	<i>R 1</i>	

<b>c.rSt</b>	Reset value	<b>ZEFO</b> or <b>P.SEt</b>	<b>ZEFO</b>	
<b>c.rSt</b>	Reset mode	<b>Lo, Hi, LoE</b> or <b>Hi, E</b>	<b>Lo</b>	
<b>SEt OPEr</b>	Set operating mode	<b>S.Prd, PErd, both, both</b> or <b>FFe9</b>	<b>FFe9</b>	
<b>bAUD RATE</b>	Baud rate	<b>300, 600, 1200, 2400, 4800, 9600, 19.2</b> or <b>38.4</b>	<b>9600</b>	
<b>Prty</b>	Parity select	<b>NONE, EVEN</b> or <b>Odd</b>	<b>NONE</b>	
<b>O.PuE</b>	Output, continuous or controlled	<b>Cont, di SP, POLL, R.buS</b> or <b>ā.buS</b>	<b>POLL</b>	
<b>Addr</b>	Set unit address for <b>POLL</b> mode	<b>0 to 31</b>	<b>0</b>	

Functions shown shaded will be seen only if the appropriate option is fitted.

<b>Settings for relays - record settings here</b>				
	<b>A1</b>	<b>A2</b>	<b>A3</b>	<b>A4</b>
<b>RxLo</b>				
<b>RxHi</b>				
<b>RxHy</b>				
<b>RxEt</b>				
<b>Rxrt</b>				
<b>Rxn.o</b> or <b>Rxn.c</b>				
<b>Rx.SP</b> or <b>Rx.t 1</b>				

## 6 Totaliser Explanation of Functions

### Totaliser functions

The description of functions in this chapter covers **totaliser** (counter/totaliser) functions only. This mode is selected at the set operation (**SET OPER**) function.



Remember that you will need to enter via **CAL** or **FUNC** mode to gain access to functions, the function table for each mode shows which functions require entry via **CAL** mode. See "Introduction" chapter for details of how to enter **FUNC** and **CAL** modes.

Functions which are common to both rate and total modes are not described in this chapter, refer to the "Ratemeter Explanation of Functions" chapter for details of these common functions.

Note: a number relays are available with certain option combinations (a maximum of 4 relays may be fitted to the RM4-TR if no other options such as retransmission are required), the alarm functions are displayed only for the actual number of relays provided. The "x" shown in the following display messages represents the alarm number i.e. **RxLo** as shown in the text will appear as **R1 Lo**, **R2Lo** etc. on the instrument display.

<b>RxPS</b>	Alarm pass value (only seen if <b>Rx.PS</b> selected at the <b>Rx.PS/Rx.tL</b> function) - see "Alarm relays" chapter.
<b>RxPt</b>	Alarm pass time (only seen if <b>Rx.PS</b> is selected at the <b>Rx.PS/Rx.tL</b> function) - see "Alarm relays" chapter.
<b>tDp; dCPt</b>	Totaliser decimal point selection - displays and sets the decimal point position for the totaliser display. For example selecting <b>0</b> will mean no decimal points (e.g. <b>25</b> ), <b>0.1</b> means 1 decimal point place (e.g. <b>25.4</b> ), <b>0.02</b> gives 2 decimal point places (e.g. <b>25.35</b> ) etc. The maximum number of decimal point places is one less than the number of digits on the display e.g. a 4 digit display can have 3 decimal points, a 5 digit display can have 4 decimal points etc.  Note: If the number of decimal point is altered then the display scaling figure ( <b>tDp; SCALE</b> ) will also be affected. Always check the scaling figure following a decimal point change and alter as required.
<b>tDp; i nPt</b>	Totaliser input pulse count - displays and sets the number of input pulses to be used with the total scale function to generate the display scaling. See examples which follow.
<b>tDp; SCALE</b>	Totaliser scale factor - displays and sets the scale factor for totaliser. Scale and input work together as follows:  New Total = Old Total + $\frac{\text{Input pulses counted} \times \text{tDp; SCALE}}{\text{tDp; i nPt}}$

**G.tot**

Grand total operating mode - by using the  or  pushbutton the display may be toggled between a total or a grand total display (or between rate, total and grand total in **both** mode). The display will briefly show either **rATE, tot!** or **G.tot** to indicate what the following total display is showing. To reset the grand total the remote input must be set to **G.tot**, see the **F: NP** function. Six modes of grand total display are provided namely:

**NONE** - no grand total display

**For** - Forward

**FEU** - Reverse

**POS** - Positive

**NEG** - Negative

**ABS** - Absolute

These modes allow a choice of how the grand total will be displayed. The total may be switched between up and down count via the "SET" input (terminal 10) and the **S: NP** function. Ensure that the "SET" link, LK4, is in before attempting to use this input to change count direction.

The following table illustrates each mode of operation.

Grand Total Mode	Up Count	Down Count
<b>NONE</b>	No effect	No effect
<b>For</b>	The grand total will increase with each up count input pulse. The grand total can show positive and negative totals.	The grand total will decrease with each down count input pulse. The grand total can show positive and negative totals.
<b>FEU</b>	The grand total will decrease with each up count input pulse. The grand total can show both positive and negative totals.	The grand total will increase with each down count input pulse. The grand total can show both positive and negative totals.
<b>POS</b>	The grand total will increase with each up count input pulse. The grand total display cannot go negative.	The grand total will not register any down count inputs i.e. the grand total will not change when down count only inputs are present. The grand total display cannot go negative.
<b>NEG</b>	The grand total will not register any up count inputs i.e. the grand total will not change when up count only inputs are present. The grand total display cannot go negative.	The grand total will increase with each down count input pulse. The grand total display cannot go negative.
<b>ABS</b>	The grand total will increase with any input pulse whether up or down count. The grand total display cannot go negative.	The grand total will increase with any input pulse whether up or down count. The grand total display cannot go negative.

**I: NPt  
EDGE**

Input edge triggering - displays and sets the input edge on which the instrument will trigger. Select **FALL** for triggering on a falling edge. Select **F: SE** for triggering on a rising edge.

**P.SET**

Preset value - this function displays and sets the preset value which the total count can be reset to. For example, if the RM4 is set to count down from a preset value then the **P.SET** function sets this value. See also **c.r SE** function which sets the reset mode and the **P.but** function which allows the  button to be used to force the preset value onto the display.

<b>SPAC</b>	Setpoint access - Sets the access to the alarm relay set points. The following choices are available: <b>R 1</b> - Allows setpoint access to alarm 1 only. <b>R 1-2</b> - Allows access to alarms 1 and 2 only. <b>R 1-3</b> allows access to alarms 1,2 and 3 etc. up to the maximum number of relays fitted. For this function to operate the remote input function must be set to <b>SP.AC</b> .															
<b>Rx.LL</b> or <b>Rx.PS</b>	Alarm relay total mode operation or alarm relay pass mode operation - see “Alarm Relays” chapter															
<b>S.I NP</b>	<p>SET terminal input - sets, in conjunction with the “SET” terminal input, the count up/down operation of the totaliser, ensure that LK10 is in and that LK11, 16 &amp; 17 are out when the SET input is used in this manner. The <b>S.I NP</b> function and the SET terminal (terminal 7) input connection may be used in one of the modes shown in the table below.</p> <table border="1"> <thead> <tr> <th><b>S.I NP</b> setting</th> <th>SET (terminal 7)</th> <th>Operation mode</th> </tr> </thead> <tbody> <tr> <td><b>L0</b></td> <td>Open i.e. no connection to terminal 7</td> <td>Count down</td> </tr> <tr> <td><b>L0</b></td> <td>Closed i.e. terminal 7 shorted to ground (terminal 9)</td> <td>Count up</td> </tr> <tr> <td><b>H, 9h</b></td> <td>Open i.e. no connection to terminal 7</td> <td>Count up</td> </tr> <tr> <td><b>H, 9h</b></td> <td>Closed i.e. terminal 7 shorted to ground (terminal 9)</td> <td>Count down</td> </tr> </tbody> </table>	<b>S.I NP</b> setting	SET (terminal 7)	Operation mode	<b>L0</b>	Open i.e. no connection to terminal 7	Count down	<b>L0</b>	Closed i.e. terminal 7 shorted to ground (terminal 9)	Count up	<b>H, 9h</b>	Open i.e. no connection to terminal 7	Count up	<b>H, 9h</b>	Closed i.e. terminal 7 shorted to ground (terminal 9)	Count down
<b>S.I NP</b> setting	SET (terminal 7)	Operation mode														
<b>L0</b>	Open i.e. no connection to terminal 7	Count down														
<b>L0</b>	Closed i.e. terminal 7 shorted to ground (terminal 9)	Count up														
<b>H, 9h</b>	Open i.e. no connection to terminal 7	Count up														
<b>H, 9h</b>	Closed i.e. terminal 7 shorted to ground (terminal 9)	Count down														
<b>c.rSt</b>	Counter reset value - the reset terminal can be programmed to cause the display to reset to either zero or the preset value programmed at the <b>P.SET</b> function. Choose either <b>ZEFO</b> or <b>P.SET</b> to select the required operation.															
<b>c.rSt</b>	Counter reset mode - Allows selection of reset level or edge to force a counter reset. If set to <b>L0</b> a low input level or closed switch on the reset line will force a reset. If set to <b>H</b> a high input level or open switch on the reset line will force a reset. If set to <b>LOE</b> then a falling edge or switch closure on the reset line will force a reset. If set to <b>HE</b> then a rising edge or switch opening on the reset line will force a reset.															
<b>cntrFSt</b>	Counter reset value - the counter reset value function allows a number to be set at which the display will automatically reset. The automatic counter reset function can be disabled by setting the function to <b>0</b> . This function is only applicable to upward counting applications i.e. the total is increasing. For example if <b>cntrFSt</b> is set to <b>100</b> and <b>c.rSt</b> is set to <b>ZEFO</b> then when the display value reaches <b>99</b> the next input pulse will cause the instrument to automatically reset to <b>0</b> .															
<b>R 1H, FSt</b>	<p>Alarm 1 high reset operation (<b>on</b> or <b>OFF</b>) - applies to relay 1 only. The alarm 1 high reset function allows the alarm operation to also cause an automatic total display reset.</p> <p>If the alarm mode is set to total (<b>R 1.LL</b>) then when the display value reaches the value set at <b>R 1H</b>, the relay will operate momentarily (the duration of the relay pulse can be extended via the <b>R 1.rE</b> function if required).</p> <p>If the alarm mode is set to pass (<b>R 1.PS</b>) then the display will reset when the display value reaches the pass value (set at <b>R 1PS</b>) and the relay will activate and will remain activated for the time set at the <b>R 1PE</b> function.</p>															

### Returning to the normal measure mode

When the calibration procedure has been completed it is advisable to return the instrument to the normal mode (where calibration functions cannot be tampered with). To return to the normal mode, turn off power to the instrument, wait a few seconds and then restore power.

## 6.1 Examples

### Flow Totalising

Flowmeters produce output pulses which may be counted and scaled to give the total flow. The number of pulses produced per litre, kilolitre etc. may be determined using the information provided by the manufacturer or from test results. The flow total scaling may be configured as follows:

**Example** - A turbine flowmeter produces 56 pulses per litre. The display is required to show total litres with 1 decimal point place. The procedure is as follows.

1. Follow the procedure shown on page 3 to enter the setup functions via **CALL** mode.
2. Step through the functions by pressing and releasing **F** until the **tot: dCPE** function is seen followed by the previous decimal point setting.
3. Use the **▲** or **▼** push button to change the **tot: dCPE** setting to **0.1**. Press **F** to accept the change.
4. Step through the functions by pressing and releasing **F** until the **tot: iNPE** function followed by the previous input value is seen.
5. Use the **▲** or **▼** push button to alter the previous input value to the new input value of **56**.
6. Press **F**, the function **tot: SCALE** will appear followed by the previous scale value.
7. Use the **▲** or **▼** push button to alter the previous scale value to the new scale value of **1**.
8. Press **F** to accept the change then either press **P** to exit or continue pressing and releasing **F** until the **FUNC End** message is seen and the display returns to normal measurement mode.

**Example** - A Rota pulse paddle wheel flowmeter (this sensor model is commonly used as an input to the RM4-TR) gives 36.5 pulses per metre flow of liquid. The flowmeter is placed in a 100mm pipe. The RM4 is required to display kilolitres to 3 decimal places. An alarm relay closure is required when a total of 53.000 kilolitres is reached.

1. Follow the procedure shown on page 5 to enter the setup functions via **CALL** mode.
2. Step through the functions by pressing and releasing **F** until the **RIH** function is seen followed by the previous high alarm setting.
3. Use the **▲** or **▼** push button to change the **RIH** setting to **53.000**. Press **F** to accept the change. Note: we will not deal with this here but in practice you will also need to consider alarm hysteresis, trip time, reset time and normally open/normally closed operation of this relay, refer to the explanations earlier chapter for further details.
4. Step through the functions by pressing and releasing **F** until the **tot: dCPE** function is seen followed by the previous decimal point setting.
5. Use the **▲** or **▼** push button to change the **tot: dCPE** setting to **0.003**. Press **F** to accept the change.
6. Step through the functions by pressing and releasing **F** until the **tot: iNPE** function followed by the previous input value is seen.
7. Use the **▲** or **▼** push button to alter the previous input value to the new input value of **1000**. See calculation below.
8. Press **F**, the function **tot: SCALE** will appear followed by the previous scale value.
9. Use the **▲** or **▼** push button to alter the previous scale value to the new scale value of **0.215**. See calculation below.
10. Press **F** to accept the change then either press **P** to exit or continue pressing and releasing **F** until the **FUNC End** message is seen and the display returns to normal measurement mode.

Calculating the input and scaling figures for the above Rota pulse example.

Assuming 36.5 pulses per meter flow of liquid and that the pipe is 100mm (0.1 metres) in diameter (0.05 metre radius). From the pipe diameter we can work out the area in metres squared and the volume in metres cubed of a 1 metre section. From the volume we can find the number of litres in the 1 metre section and hence the number of kilolitres in this section.

$$Area = \pi r^2 = \pi \times 0.05^2 = 0.00785 \text{ m}^2$$

The volume of a 1 metre length is:  $Volume = area \times length = 0.00785 \times 1 = 0.00785 \text{ m}^3$

Since there are 1000 litres in one cubic meter we can find the number of litres in this one metre length of pipe:  $Litres \text{ per metre length} = volume \times 1000 = 0.00785 \times 1000 = 7.85 \text{ Litres}$

If there are 7.85 litres per metre length and there are 36.5 pulses per metre length then each pulse represents 0.215 litres (from 7.85 divided by 36.5) or 0.000215 kilolitres. If we had enough decimal point places we could use a **tot: iNPE** factor of 1 and a **tot: SCALE** factor of 0.000215 to give a display in

kilolitres. Since we require 3 decimal places only then multiplying both figures by 1000 will give the same scaling result and figures of:  $\text{COUNT} / \text{PPR} = 1000$  and  $\text{COUNT} / \text{SCALE} = 0.215$ .

It is the ratio between  $\text{COUNT} / \text{PPR}$  and  $\text{COUNT} / \text{SCALE}$  which determines the scaling factor and so there are many input and scale figures which are equally valid e.g.  $\text{COUNT} / \text{PPR} = 100000$  and  $\text{COUNT} / \text{SCALE} = 21.5$  would give the same display scaling as would  $\text{COUNT} / \text{PPR} = 4651$  and  $\text{COUNT} / \text{SCALE} = 1$ .

The table below shows approximate Rota pulse scaling figures for typical pipe diameters:-

Pipe diameter	Litres	Kilolitres or cubic metres
25mm	$\text{COUNT} / \text{PPR} = 74316$ $\text{COUNT} / \text{SCALE} = 1000$	$\text{COUNT} / \text{PPR} = 74316$ $\text{COUNT} / \text{SCALE} = 1$
40mm	$\text{COUNT} / \text{PPR} = 29029$ $\text{COUNT} / \text{SCALE} = 1000$	$\text{COUNT} / \text{PPR} = 29029$ $\text{COUNT} / \text{SCALE} = 1$
50mm	$\text{COUNT} / \text{PPR} = 18579$ $\text{COUNT} / \text{SCALE} = 1000$	$\text{COUNT} / \text{PPR} = 18579$ $\text{COUNT} / \text{SCALE} = 1$
80mm	$\text{COUNT} / \text{PPR} = 7257$ $\text{COUNT} / \text{SCALE} = 1000$	$\text{COUNT} / \text{PPR} = 7257$ $\text{COUNT} / \text{SCALE} = 1$
100mm	$\text{COUNT} / \text{PPR} = 4645$ $\text{COUNT} / \text{SCALE} = 1000$	$\text{COUNT} / \text{PPR} = 4645$ $\text{COUNT} / \text{SCALE} = 1$
150mm	$\text{COUNT} / \text{PPR} = 2064$ $\text{COUNT} / \text{SCALE} = 1000$	$\text{COUNT} / \text{PPR} = 2064$ $\text{COUNT} / \text{SCALE} = 1$

The scaling factors above are approximate and will vary depending on pipe size and installation conditions. A calibration should be carried out to determine the correct scaling for any installation where accuracy is required.

### Examples - Item counting

For applications in which items are being counted e.g. bottles, or pulses are being counted to give displays in total revolutions or length travelled you will need to find out how many pulses equals a given number of display units. From this information you can work out suitable input and scale factors. The table below gives some general scaling examples. The examples which follow illustrate the calculation of scaling figures and settings required for typical applications.

**Example - up counting** - An encoder is connected to a shaft. The encoder puts out 1000 pulses per revolution. The encoder is connected to a threaded shaft. The totaliser is to show the distance travelled by an object connected to the shaft. The object travels a distance of 2.5 mm per revolution of the shaft i.e. 1000 pulses = 2.5 mm travel or 400 pulses = 1 mm travel. The measurement is to be in metres with 3 decimal points to give a resolution in mm.

1. Follow the procedure shown on page 3 to enter the setup functions via **CALL** mode.
2. Step through the functions by pressing and releasing **F** until the **COUNT / PPR** function is seen followed by the previous decimal point setting.
3. Use the **▲** or **▼** push button to change the **COUNT / PPR** setting to **0.003**. Press **F** to accept the change.
4. Step through the functions by pressing and releasing **F** until the **COUNT / PPR** function followed by the previous input value is seen.
5. Use the **▲** or **▼** push button to alter the previous input value to the new input value of **400**.
6. Press **F**, the function **COUNT / SCALE** will appear followed by the previous scale value.
7. Use the **▲** or **▼** push button to alter the previous scale value to the new scale value of **0.001**.
8. Press **F** to accept the change then either press **P** to exit or continue pressing and releasing **F** until the **FUNC End** message is seen and the display returns to normal measurement mode.

**Example** - down counting - A proximity sensor is counting objects on a conveyor belt. When 2000 objects have passed the RM4 is to force its internal relay to open which will be used to de-activate a solenoid and halt the conveyor. The display is required to count down from the preset value of 2000 to zero. The input and scale factors in this case will both be 1 since the display is simply counting objects. Other settings needed in this example are some alarm settings, the preset value, the SET input mode and the counter reset value.

1. Follow the procedure shown on page 3 to enter the setup functions via **CAL** mode.
2. The first function is **R !Lo** this will be seen followed by the previous low alarm setting.
3. Use the **▲** or **▼** push button to change the **R !Lo** setting to **0**. Press **F** to accept the change.
4. Step through the functions by pressing and releasing **F** until the **R In.o/R In.c** function is seen.
5. Use the **▲** or **▼** push button to change the setting to **R In.c** (normally closed operation).
6. Step through the functions by pressing and releasing **F** until the **Set: I NPt** function followed by the previous input value is seen.
7. Use the **▲** or **▼** push button to alter the previous input value to the new input value of **1**.
8. Press **F**, the function **Set: SCALE** will appear followed by the previous scale value.
9. Use the **▲** or **▼** push button to alter the previous scale value to the new scale value of **1**.
10. Step through the functions by pressing and releasing **F** until the **PSEt** function is seen followed by the previous preset value. Note: If the display has a front panel **P** button then the function of this button can be programmed to allow fast access to the preset value without needing to enter **CAL** mode. This facility can be useful if the preset value is likely to be changed regularly.
11. Use the **▲** or **▼** push button to change the setting to **2000**.
12. Step through the functions by pressing and releasing **F** until the **S: NP** function followed by the previous SET input mode is seen.
13. Use the **▲** or **▼** push button to change the setting to **Lo**. This will force the instrument to count down.
14. Step through the functions by pressing and releasing **F** until the first **c.r St** function followed by the previous reset value is seen.
15. Use the **▲** or **▼** push button to change the setting to **P.SEt**. This will force the instrument display to revert to the preset value whenever the display is reset.
16. Press **F** to accept the change then either press **P** to exit or continue pressing and releasing **F** until the **FUNC End** message is seen and the display returns to normal measurement mode.

# 7 Totaliser Function Table



Initial display	Meaning of display	Next display	Default Setting	Record Your Settings
<i>RxPS</i>	Alarm pass value	Pass value or <i>OFF</i>	<i>OFF</i>	See following table
<i>RxPt</i>	Alarm pass time	Time in seconds	<i>0.0</i>	See following table
<i>RxLo</i>	Alarm low setpoint value	Setpoint value or <i>OFF</i>	<i>OFF</i>	See following table
<i>RxHi</i>	Alarm high setpoint value	Setpoint value or <i>OFF</i>	<i>OFF</i>	See following table
<i>RxHy</i>	Alarm hysteresis	Hysteresis value in measured units	<i>10</i>	See following table
<i>Rxtt</i>	Alarm trip time	No of seconds before relay trips	<i>0</i>	See following table
<i>Rxrt</i>	Alarm reset time	No of seconds before relay resets	<i>0</i>	See following table
<i>Rxn.o</i> or <i>Rxn.c</i>	Alarm action N/O or N/C	<i>Rxn.o</i> or <i>Rxn.c</i>	<i>Rxn.o</i>	See following table
<i>RxSP</i> or <i>Rxt!</i>	Setpoint or trailing alarm	<i>RxSP</i> or <i>Rxt!</i>	<i>RxSP</i>	See following table
<i>brgt</i>	Digital display brightness	<i>0</i> to <i>15</i> ( <i>15</i> = highest brightness)	<i>15</i>	
<i>dULL</i>	Remote input brightness control	<i>0</i> to <i>15</i> ( <i>15</i> = highest brightness)	<i>0</i>	
<i>d.oFF SECS</i>	Display auto dimming timer (seconds)	<i>0</i> to <i>9999</i>	<i>0</i>	
Functions below are accessible via <i>CAL</i> mode only.				
<i>FEC-</i>	Analog retransmission low value	Value in memory	<i>0</i>	
<i>FEC+</i>	Analog retransmission high value	Value in memory	<i>1000</i>	
<i>rEC- Ch2</i>	Analog retransmission 2 low value	Value in memory	<i>0</i>	
<i>rEC+ Ch2</i>	Analog retransmission 2 high value	Value in memory	<i>1000</i>	
<i>tot! dCPE</i>	Decimal point setting for totaliser display	Value in memory	<i>0</i>	
<i>tot! iNPE</i>	Totaliser input setting	Value in memory	<i>1</i>	
<i>tot! SCLE</i>	Totaliser scale setting	Value in memory	<i>1</i>	
<i>9.tot</i>	Grand total operating mode	<i>NONE</i> . <i>For</i> . <i>FEU</i> . <i>POS</i> . <i>NEG</i> . <i>ABS</i>	<i>NONE</i>	
<i>iNPE EdGE</i>	Input edge triggering rising or falling edge	<i>FALL</i> or <i>RISE</i>	<i>RISE</i>	
<i>RI NP</i>	Remote input	<i>NONE</i> , <i>P.HLd</i> , <i>d.HLd</i> , <i>H. Lo</i> , <i>H. Lo, ZEF0</i> , <i>SP.Ac</i> , <i>No.Ac</i> , <i>d! SP.dULL</i> or <i>9.rSt</i>	<i>NONE</i>	
<i>P.but</i>	 button operation	<i>NONE</i> , <i>H. Lo</i> , <i>H. Lo, ZEF0</i> . <i>d! SP.FUNC</i> or <i>9.fSt</i>	<i>NONE</i>	
<i>ACCS</i>	Alarm relay access mode	<i>OFF</i> , <i>ERSY</i> . <i>NONE</i> or <i>ALL</i>	<i>OFF</i>	
<i>SPAC</i>	Setpoint access	<i>R1</i> . <i>R1-2</i> etc.	<i>R1</i>	
<i>Rx.tL/Rx.PS</i>	Alarm operation mode total or pass	<i>Rx.tL</i> or <i>RxPS</i>	<i>Rx.tL</i>	See following table
<i>PSEt</i>	Preset value	Value in memory	<i>0</i>	
<i>S.i NP</i>	SET terminal low or high input operation	<i>Lo</i> or <i>hi, gh</i>	<i>hi, gh</i>	
<i>c.rSt</i>	Reset value zero or preset	<i>ZEF0</i> or <i>P.SEt</i>	<i>ZEF0</i>	
<i>c.rSt</i>	Reset mode	<i>Lo</i> , <i>H. LoE</i> or <i>H. E</i>	<i>Lo</i>	
<i>cntr fSt</i>	Counter reset value	Value in memory	<i>0</i>	
<i>R1H. fSt</i>	Alarm 1 high reset	<i>on</i> or <i>OFF</i>	<i>OFF</i>	
<i>SEt OPEr</i>	Set operating mode. Note: only <i>both</i> . <i>totL</i> & <i>FfE9</i> are applicable to this manual	<i>S.Pr.d</i> . <i>PEr.d</i> . <i>both</i> . <i>totL</i> . or <i>FfE9</i>	<i>FfE9</i>	
<i>baud rAtE</i>	Baud rate	<i>300</i> . <i>600</i> . <i>1200</i> . <i>2400</i> . <i>4800</i> . <i>9600</i> . <i>19.2</i> or <i>38.4</i>	<i>9600</i>	
<i>Prty</i>	Parity select	<i>NONE</i> . <i>EVEN</i> or <i>Odd</i>	<i>NONE</i>	
<i>O.Put</i>	Output, continuous or controlled	<i>d! SP.Cont</i> . <i>POLL</i> . <i>R.buS</i> or <i>r.buS</i>	<i>POLL</i>	
<i>Addr</i>	Set unit address for <i>POLL</i> mode	<i>0</i> to <i>31</i>	<i>0</i>	

Functions shown shaded will be seen only if the appropriate option is fitted.

<b>Settings for relays - record settings here</b>				
	A1	A2	A3	A4
<b>RxPS</b>				
<b>RxPt</b>				
<b>RxLo</b>				
<b>RxH<sub>1</sub></b>				
<b>RxHY</b>				
<b>RxL<sub>1</sub></b>				
<b>RxL<sub>2</sub></b>				
<b>Rxn.o or Rxn.c</b>				
<b>Rx.SP or Rx.t<sub>1</sub></b>	n/a			
<b>Rx.PS or Rx.t<sub>L</sub></b>				

## 8 Both Mode

When **both** mode is selected at the **SEt OPEr** function the user has the option of toggling between the displays available in both totaliser and ratemeter modes. This allows the meter to be used as a ratemeter/totaliser. When **both** mode is used the functions available allow for both the ratemeter and totaliser scaling and setup.

If front panel pushbuttons are fitted to the display type being used then the  and  buttons can be used to toggle between totaliser and ratemeter displays. Alternatively a remote input contact closure can be used across terminals 5 and 9. If these terminals are to be used to toggle between displays then the remote input function **r.i NP** must be set to **d: SP**.

Since the functions available in this mode are a combination of ratemeter and totaliser functions the explanation of **both** mode functions can be found by referring to the appropriate ratemeter or totaliser chapter. The functions not described in other chapters are:

**Rx** - relay mode, allows choice of relay operation of rate (**Rx.rL**), total (**Rx.tL**) or pass mode (**Rx.PS**).

**FEE** - optional retransmission 1 mode, allows choice of retransmission of rate (**rALtE**) or total (**tALt**).

**FEE2** - optional retransmission 2 mode, allows choice of retransmission of rate (**rALtE**) or total (**tALt**).

The function table below lists all of the functions available in **both** mode.

### 8.1 Both Mode Function Table

Initial display	Meaning of display	Next display	Default Setting	Record Your Settings
<b>RxPS</b>	Alarm pass value	Pass value or <b>OFF</b>	<b>OFF</b>	See following table
<b>RxPt</b>	Alarm pass time	Time in seconds	<b>0.0</b>	See following table
<b>RxLo</b>	Alarm low setpoint value	Setpoint value or <b>OFF</b>	<b>OFF</b>	See following table
<b>RxHi</b>	Alarm high setpoint value	Setpoint value or <b>OFF</b>	<b>OFF</b>	See following table
<b>RxHY</b>	Alarm hysteresis	Hysteresis value in measured units	<b>10</b>	See following table
<b>Rxtt</b>	Alarm trip time	No of seconds before relay trips	<b>0</b>	See following table
<b>RxrL</b>	Alarm reset time	No of seconds before relay resets	<b>0</b>	See following table
<b>Rxn.o</b> or <b>Rxn.c</b>	Alarm action N/O or N/C	<b>Rxn.o</b> or <b>Rxn.c</b>	<b>Rxn.o</b>	See following table
<b>RxSP</b> or <b>Rxt!</b>	Setpoint or trailing alarm	<b>RxSP</b> or <b>Rxt!</b>	<b>RxSP</b>	See following table
<b>brgt</b>	Digital display brightness	<b>1</b> to <b>15</b> ( <b>15</b> = highest brightness)	<b>15</b>	
<b>dULL</b>	Remote input brightness control	<b>0</b> to <b>15</b> ( <b>15</b> = highest brightness)	<b>0</b>	
<b>d.oFF SECS</b>	Display auto dimming timer (seconds)	<b>0</b> to <b>9999</b>	<b>0</b>	
<b>Functions below are accessible only via <b>CAL</b> mode</b>				
<b>FEE<sub>~</sub></b>	Analog retransmission low value	Value in memory	<b>0</b>	
<b>FEE<sup>~</sup></b>	Analog retransmission high value	Value in memory	<b>1000</b>	
<b>rEE<sub>~</sub> Ch2</b>	Analog retransmission 2 low value	Value in memory	<b>0</b>	
<b>rEE<sup>~</sup> Ch2</b>	Analog retransmission 2 high value	Value in memory	<b>1000</b>	
<b>drnd</b>	Display rounding, selects resolution	Value in memory	<b>1</b>	
<b>FLtr</b>	Digital filter range 0 to 8	<b>0</b> to <b>8</b> ( <b>8</b> = most filtering)	<b>2</b>	
<b>rALt dCPE</b> or <b>PERd dCPE</b>	Decimal point setting for rate display or decimal point setting for period depending upon the <b>d: SP</b> setting	Value in memory	<b>0</b>	
<b>rALt i NPt</b> or <b>PERd i NPt</b>	Rate input setting (Hz) or Period input setting (S) depending upon the <b>d: SP</b> setting	Value in memory	<b>1</b>	
<b>rALt SCLt</b> or <b>PERd SCLt</b>	Rate scale setting or Period scale setting depending upon the <b>d: SP</b> setting	Value in memory	<b>1</b>	

Initial display	Meaning of display	Next display	Default Setting	Record Your Settings
<i>dot dCPt</i>	Decimal point setting for totaliser display	Value in memory	<b>0</b>	
<i>dot i nPt</i>	Totaliser input setting	Value in memory	<b>1</b>	
<i>dot sCLE</i>	Totaliser scale setting	Value in memory	<b>1</b>	
<b>9.tot</b>	Grand total operating mode	<b>NONE</b> , For <b>FEE</b> , <b>POS</b> , <b>NEG</b> or <b>ABS</b>	<b>NONE</b>	
<b>FREQ RNGE</b>	Frequency range low or high frequency	<b>H, F, LoF</b> or <b>RNGE</b>	<b>H, F</b>	
<b>FAST UPdt</b>	Fast update mode	<b>on</b> or <b>OFF</b>	<b>OFF</b>	
<b>i nPt EdGE</b>	Input edge triggering rising or falling edge	<b>FALL</b> or <b>RI SE</b>	<b>RI SE</b>	
<b>di SP</b>	Default display for low frequency input (seen only when <b>FREQ RNGE</b> set to <b>LoF</b> )	<b>rAtE</b> or <b>PERd</b>	<b>rAtE</b>	
<b>di SP RNgE</b>	Display range (seen only when <b>di SP</b> set to <b>PERd</b> )	<b>0.0.0</b> to <b>0.00.02</b>	<b>0</b>	
<b>timeout SECS</b>	Timeout (seen only when <b>FREQ RNGE</b> set to <b>RNGE</b> or <b>LoF</b> )	Value in memory	<b>0</b>	
<b>RNGE SECS</b>	Averaging time (seen only when <b>FREQ RNGE</b> set to <b>RNGE</b> )	Value in memory	<b>0</b>	
<b>r i nP</b>	Remote input	<b>NONE</b> , <b>P.HLd</b> , <b>d.HLd</b> , <b>H, Lo</b> , <b>H, Lo</b> , <b>ZEFO</b> , <b>SP.Rc</b> , <b>No.Rc</b> , <b>di SP.duLL</b> or <b>g.rSt</b>	<b>NONE</b>	
<b>P.but</b>	<b>P</b> button operation	<b>NONE</b> , <b>H, Lo</b> , <b>H, Lo</b> , <b>ZEFO</b> , <b>di SP.FUNC</b> or <b>g.rSt</b>	<b>NONE</b>	
<b>ALCS</b>	Alarm relay access mode	<b>OFF</b> , <b>ERSY</b> , <b>NONE</b> or <b>ALL</b>	<b>OFF</b>	
<b>SPAC</b>	Setpoint access	<b>A 1, A 1-2</b> etc.		
<b>ALrE/AL.tL/AL.PS</b>	Alarm operation mode rate, total or pass	<b>ALrE</b> , <b>AL.tL</b> or <b>ALPS</b>	<b>ALrE</b>	See following table
<b>FEC</b>	Analog retransmission 1 output mode	<b>dot</b> or <b>rAtE</b>	<b>rAtE</b>	
<b>FEC2</b>	Analog retransmission 2 output mode	<b>dot</b> or <b>rAtE</b>	<b>rAtE</b>	
<b>P.SEt</b>	Preset value	Value in memory	<b>0</b>	
<b>S i nP</b>	SET terminal operation	<b>Lo</b> or <b>h, 9h</b>	<b>h, 9h</b>	
<b>c.rSt</b>	Reset value	<b>ZEFO</b> or <b>P.SEt</b>	<b>ZEFO</b>	
<b>c.rSt</b>	Reset mode	<b>Lo</b> , <b>H, LoE</b> or <b>H, E</b>	<b>Lo</b>	
<b>cnt.rSt</b>	Counter reset value	Value in memory	<b>0</b>	
<b>ALH, rSt</b>	Alarm 1 high reset	<b>on</b> or <b>OFF</b>	<b>OFF</b>	
<b>dF: t di SP</b>	Default display rate, total or period, total depending upon the <b>di SP</b> setting	<b>rAtE</b> , <b>dot</b> or <b>PERd</b> , <b>dot</b>	<b>rAtE</b>	
<b>SEt OPEr</b>	Set operating mode	<b>S.Pr.d</b> , <b>PERd</b> , <b>both</b> , <b>dot</b> or <b>FREQ</b>	<b>FREQ</b>	
<b>BAUD rAtE</b>	Baud rate	<b>300</b> , <b>600</b> , <b>1200</b> , <b>2400</b> , <b>4800</b> , <b>9600</b> , <b>19.2</b> or <b>38.4</b>	<b>9600</b>	
<b>Prty</b>	Parity select	<b>NONE</b> , <b>EVEN</b> or <b>Odd</b>	<b>NONE</b>	
<b>OPut</b>	Output, continuous or controlled	<b>di SP</b> , <b>Cont</b> , <b>POLL</b> , <b>ABS</b> or <b>ABS</b>	<b>POLL</b>	
<b>Addr</b>	Set unit address for <b>POLL</b> mode	<b>0</b> to <b>31</b>	<b>0</b>	

Note: Functions shown shaded will be seen only if the appropriate option is fitted

<b>Settings for relays - record settings here</b>				
	A1	A2	A3	A4
<b>RxPS</b>				
<b>RxPt</b>				
<b>RxLo</b>				
<b>RxHi</b>				
<b>RxHY</b>				
<b>Rxtt</b>				
<b>Rxr t</b>				
<b>Rxn.o or Rxn.c</b>				
<b>Rx.SP or Rx.t!</b>	n/a			
<b>Rxr t .Rx.PS or Rx.tL</b>				

## 9 Alarm relays

The RM4 is provided with 2 alarm relays as standard. One or two extra optional independent alarm relays may also be provided, these relays are designated **R1**, **R2** etc. Each alarm has the following parameters which may be set by the user:

1. Low trip point, adjustable in measurement units.
2. High trip point, adjustable in measurement units.
3. Alarm hysteresis, adjustable in measurement units.
4. Alarm trip time, adjustable in one second steps.
5. Alarm reset time, adjustable in one second steps.
6. N/O or N/C relay operation.
7. Independent or trailing alarms (available on relays 2 and upwards)
8. Pass alarm mode (totaliser operation only).

Note that the alarm settings are not changed when calibration scaling channels are changed. The alarms operate in the following way:

If the measured value is above the High Trip Point, or below the Low Trip Point, the alarm trip timer starts. This timer is reset if the measured value drops below the High Trip Point or above the Low Trip point. When the alarm trip timer's time exceeds the Trip delay time, the alarm is operated.

When the alarm has tripped, the measured value is compared to the High Set Point less the Hysteresis value and the Low Set Point plus the Hysteresis value. If it is less than the High Set Point less the Hysteresis value and greater than the Low Set Point plus the Hysteresis value, the alarm is reset.

### Alarm low setpoint (**RxL**)

Displays and sets the low setpoint value for the designated alarm relay. The low alarm setpoint may be disabled by pressing the **▲** and **▼** keypads simultaneously. When the alarm is disabled the display will indicate **OFF**. Use **▲** or **▼** to adjust the setpoint value if required. The alarm will activate when the displayed value is lower than the **RxL** setpoint value. Each relay may be configured with both a low and high setpoint if required, if so the relay will be activated when the display reading moves outside the band set between low and high setpoints.

### Alarm high setpoint (**RxH**)

Displays and sets the high setpoint value for the designated alarm relay. The high alarm setpoint may be disabled by pressing the **▲** and **▼** keypads simultaneously. When the alarm is disabled the display will indicate **OFF**. Use **▲** or **▼** to adjust the setpoint value if required. The alarm will activate when the displayed value is higher than the **RxH** setpoint value. Each relay may be configured with both a low and high setpoint if required, if so the relay will be activated when the display reading moves outside the band set between low and high setpoints.

### Alarm hysteresis (**RxHY**)

Displays and sets the alarm hysteresis limit and is common for both high and low setpoint values. The hysteresis value may be used to prevent too frequent operation of the setpoint relay when the measured value stays close to the setpoint. Without a hysteresis setting (**RxHY** set to zero) the alarm will activate when the display value goes above the alarm setpoint (for high alarm) and will reset when the display value falls below the setpoint, this can result in repeated on/off switching of the relay at around the setpoint value. The hysteresis setting operates as follows:

In the high alarm mode, once the alarm is activated the input must fall below the setpoint value minus the hysteresis value to reset the alarm.

e.g. if **RxH** is set to **50.0** and **RxHY** is set to **3.0** then the setpoint output relay will activate once the display value goes above **50.0** and will reset when the display value goes below **47.0** (**50.0** minus **3.0**).

In the low alarm mode, once the alarm is

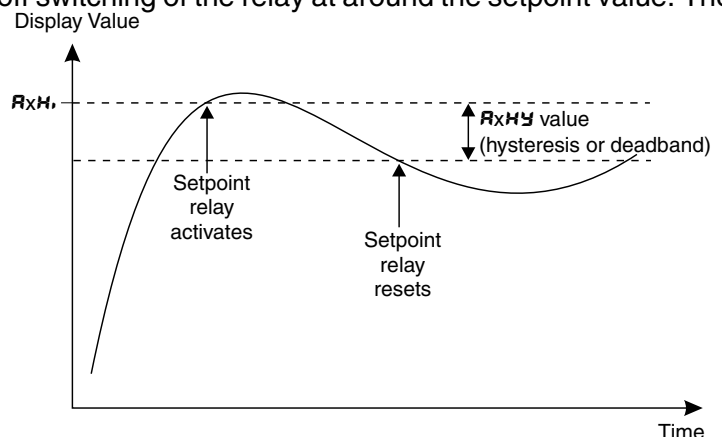

activated the input must rise above the setpoint value plus the hysteresis value to reset the alarm.

e.g. if **R1Lo** is set to **20.0** and **R1Hh** is set to **10.0** then the alarm output relay will activate when the display value falls below **20.0** and will reset when the display value goes above **30.0** (20.0 plus 10.0).

The hysteresis units are expressed in displayed engineering units.

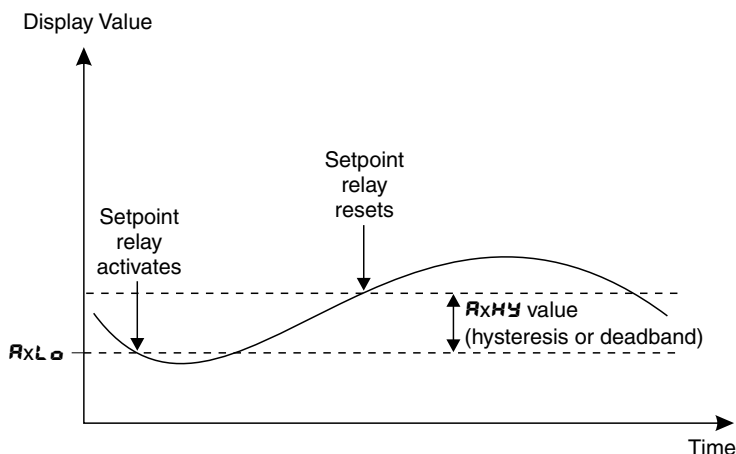

### Alarm trip time (**Rxtt**)

The alarm trip time determines how long the measured value has to be above the high trip point or below the low trip point before an alarm is given. This can be used to prevent false alarms on noisy inputs. The value is set in seconds, with a range of **0** to **60** seconds. For normal operation a delay of three to five seconds is suitable.

### Alarm reset time (**Rxrt**)

The alarm reset time determines how long the measured value has to be below the high trip point or above the low trip point before the alarm is reset. The value is set in seconds, with a range of **0** to **60** seconds. For normal operation a delay of zero seconds is suitable.

### Alarm relay N/O or N/C operation (**Rxn.o/n.c**)

Each alarm may be programmed to operate as a normally open (N/O e.g. **R1 n.o**) or normally closed (N/C e.g. **R2 n.c**) device. A N/O relay is de-energised when no alarm condition is present and is energised when an alarm condition is present. A N/C relay is normally energised and is de-energised when an alarm condition is present. The N/C mode is useful for power failure detection.

### Alarm pass value (**RxPS**) - only seen if **Rx.PS** selected at the **Rx.PS/Rx.tL** function.

Displays and sets the alarm pass value (see **Rx.PS/Rx.tL** function). The alarm relay will activate at multiples of the pass value e.g. if **RxPS** is set to **50** then the relay will activate at a total display value of **50**, **100**, **150** etc. The time for which the relay remains activated at each pass value is set via the **RxPtt** function which follows. The pass value may be set anywhere in the display range of the instrument.

### Alarm pass time (**RxPtt**) - only seen if **Rx.PS** selected at the **Rx.PS/Rx.tL** function.

Displays and sets the alarm pass time in seconds & tenths of seconds within the range **0.0** to **999.9** seconds. The value set is the time for which the relay will remain energised when activated at a pass value. e.g. if set to **2.0** with a **RxPS** value of **50** then the relay will remain energised for 2.0 seconds every time the display passes a multiple of 50. **Note:** If the pass time exceeds the time taken to reach consecutive pass values then the RM4 will “store” any relay operations it does not have time to activate and will perform these activations when the total display update rate allows. For this reason the relay may be seen to activate repeatedly for a period after the total update rate has slowed down or stopped.

### Alarm relay operation mode (**Rx.tL/Rx.PS**)

Each alarm relay can be set to operate as either a standard setpoint relay when **Rx.tL** is selected or as a “pass value” relay when **Rx.PS** is selected.

With **Rx.tL** selected the relay will operate from the high and/or low setpoints (**RxHt** and **RxLo**). Values for hysteresis, trip time, reset time, normally open/normally closed operation and setpoint or trailing alarms can also be set. The pass functions **RxPS** and **RxPtt** will not be seen in if the **Rx.tL** mode is selected.

With **Rx.PS** selected the relay will operate on a pass value i.e. it will operate on multiples of the **RxPS** value set (the first function described in this chapter). See **RxPS** and **Rx.tL** for further description of operation. The setpoint functions **RxLo**, **RxHt**, **RxHh**, **Rxtt**, **Rxrt**, **RxSP/Rx.tL** will not be seen if the **Rx.PS** mode is selected.

## Trailing or independent set points

A function exists to allow relays, other than relay 1, to be used as independent relays with their own set points or they may be made to “trail” another relays setpoint. For example if **R2.SP** is selected then alarm 2 will act as an independent relay. If **R2.L 1** is selected then the alarm 2 relay will trail alarm 1 relay. With **R2.L 1** selected if alarm 1 high setpoint is set to 50 and alarm 2 high set point set to 20 then alarm 2 relay will operate at a display of 70 (50 + 20). Alternatively alarm 2 could be set to operate at 30 (50 - 20) by setting alarm 2 high setpoint to -20.

Trailing Alarm Table Showing Possible Alarm Assignments			
	<b>R2</b>	<b>R3</b>	<b>R4</b>
<b>R1</b>	<b>R2.L 1</b>	<b>R3.L 1</b>	<b>R4.L 1</b>
<b>R2</b>		<b>R3.L 2</b>	<b>R4.L 2</b>
<b>R3</b>			<b>R4.L 3</b>

## 9.1 Easy Alarm Access

The RM4 has an easy alarm access facility which allows operator access to the selected alarm setpoints (only to the setpoints selected at the **SP.AC** function) simply by pressing the **F** button. The first setpoint will then appear and changes to this setpoint may be made to this setpoint via the **▲** or **▼** buttons. Press the **F** button to accept any changes or to move on to the next setpoint.

The instrument must be set in the manner described below to allow the easy access facility to work:

1. Either the **ACCS** function must be set to **EASY** or the **R.I NP** function must be set to **SP.AC**. If the **ACCS** function is used the remote input function **R.I NP** can be assigned to a different use.
2. The selected relays must have a setpoint, nothing will happen if all the alarm relay setpoints are set to **OFF**.
3. The **SP.AC** function must be set to allow access to the relays required e.g. if set to **R 1-2** then the easy access will work only with alarm relays 1 and 2 even if more relays are fitted.
4. The instrument must be in normal measure mode i.e. if the instrument is powered up so that it is in **CAL** mode then the easy access will not function. If in doubt then remove power from the instrument, wait for a few seconds then apply power again.
5. If the easy access facility is used then the only way to view or alter any other function settings is to power up via **CAL** mode i.e. there is no entry to **FUNC** mode unless the instrument is powered up in **CAL** mode.

### Optional relays

Two alarm relays are fitted as standard. One or two extra relays are optionally available. See appropriate appendix in this manual for details of optional relays.

### Switching Inductive Loads

If the alarm relay is to be used to switch an inductive load, such as a solenoid, it is advisable to use a suppressor circuit either across the load or across the relay contacts. Switching inductive loads without a suppressor circuit can cause arcing at the relay contacts resulting in electrical interference and wear on the contacts. A typical suppressor circuit consists of a 100Ω resistor in series with a 0.1 uF capacitor, this circuit is then placed across the load or relay contacts. Ensure that the resistor and capacitor are of sufficiently high rating to cope with the voltage and current encountered.

---

## 10 Specifications

---

### 10.1 Technical Specifications

Count/rate input:	Link selectable internal pull up resistor, internal pull down resistor, biased input, DC couple and 2V added hysteresis. For inductive, AC and square wave inputs the maximum input voltage is 48VDC or RMS with appropriate link settings
Totaliser functions:	Scaleable up or down counter. Total and grand total memory
Ratemeter functions:	Scaleable rate or period display
Accuracy:	For frequency or period measurement 0.01% ±10uS
Impedance:	10KΩ
Max count rate:	100kHz
Memory retention:	Total/grand total memory retained for a minimum of forty days with power removed.
Totaliser reset:	Total reset via contact closure (or 5V control voltage) across terminals 5 & 9. Grand total reset via contact closure across terminals 6 & 9. Note: <b>FRIP</b> function must be set to <b>9.F5E</b> if grand total reset operation is required
Microprocessor:	MC68HC11 CMOS
Ambient temperature:	-10 to 60°C
Humidity:	5 to 95% non condensing
Display:	LED 5 digit 7.6mm + alarm annunciator LEDs
Power Supply:	AC 240V, 110V, 24V or 32V 50/60Hz DC 12 to 48V wide range
Power consumption:	AC supply 4 VA max, DC supply, consult supplier (depends on options fitted)
Output (standard):	2 x relays, form A rated 5A resistive 240VAC 5V or 24VDC unregulated transmitter supply (common ground) rated at 25mA, available on both AC and DC powered models

### 10.2 Output Options

Third Relay:	Rated 0.5A resistive 30VAC or DC. May be configured for either form A or form C if the third relay is the only option fitted
Fourth Relay:	Rated 0.5A resistive 30VAC or DC, form A
Switched Voltage:	Non isolated 24VDC output to be used for open collector or solid state relay driver output
Analog Retransmission:	Isolated 4 to 20mA or 0 - 1V or 0 - 10V link selectable, 12 bit or 16 bit versions available.
Serial Communications:	Configurable as retransmission or PI control. RS232, RS485 or RS422 factory configured The rate/total update rate for serial communications is twice per second with <b>FRSt UPdt</b> set to <b>OFF</b> or approx. twenty per second with <b>FRSt UPdt</b> set to <b>on</b>
Transmitter supply:	Isolated & regulated. Link selectable 12VDC (50mA max) or 24VDC (25mA max)

### 10.3 Physical Characteristics

Case Size:	44mm (w) x 91mm (h) x 141mm (d)
Connections:	Plug in screw terminals (max 1.5mm <sup>2</sup> wire for input signal and options 2.5mm <sup>2</sup> for power and relays 1 & 2)
Weight:	470 gms basic model, 500 gms with option card

---

## 11 Guarantee and Service

---

The product supplied with this manual is guaranteed against faulty workmanship for a period of 2 years from the date of dispatch.

Our obligation assumed under this guarantee is limited to the replacement of parts which, by our examination, are proved to be defective and have not been misused, carelessly handled, defaced or damaged due to incorrect installation. This guarantee is VOID where the unit has been opened, tampered with or if repairs have been made or attempted by anyone except an authorised representative of the manufacturing company.

Products for attention under guarantee (unless otherwise agreed) **must be returned to the manufacturer freight paid** and, if accepted for free repair, will be returned to the customers address in Australia free of charge.

When returning the product for service or repair a full description of the fault and the mode of operation used when the product failed must be given.

In any event the manufacturer has no other obligation or liability beyond replacement or repair of this product.

Modifications may be made to any existing or future models of the unit as it may deem necessary without incurring any obligation to incorporate such modifications in units previously sold or to which this guarantee may relate.

**This document is the property of  
the instrument manufacturer  
and may not be reproduced in whole or part without the  
written consent of the manufacturer.**

**This product is designed and manufactured in Australia.**

