

**Model PM4-IV3
Arithmetic Process Monitor/
Scanning Monitor
3 Channel Input
4-20mA, 0-1V, 0-10V or 0-100V
Operation and Instruction Manual**

AMALGAMATED INSTRUMENT CO

*Unit 5, 28 Leighton Place Hornsby
NSW 2077 Australia*

*Telephone: +61 2 9476 2244
Facsimile: +61 2 9476 2902*

*ABN: 80 619 963 692
e-mail: sales@aicpl.com.au
Internet: www.aicpl.com.au*

Table of Contents



1	Introduction	3
2	Mechanical Installation	5
3	Electrical installation	6
4	Function tables - summary of setup functions	12
5	Explanation of functions	17
6	Calibration	41
7	Arithmetic Functions	43
8	Specifications	46
9	Guarantee and service	47



1 Introduction

1.1 General description

This manual contains information for the installation and operation of the PM4-IV3 Arithmetic/Scanning Monitor this is a special purpose instrument which may be configured to accept up to three inputs of DC volts or 4 to 20 mA DC.

Two basic modes of operation are available, namely **arithmetic** and **scanning** modes. The mode of operation is set at the **SET OPER** function where the options of **Arth** or **SCAN** are given.

In arithmetic mode the instrument may be programmed to perform an arithmetic function on up to three inputs and provide a resultant display in engineering units. In arithmetic mode the primary display (channel 0) is the result of the arithmetic function performed by the instrument. Each channel (0 to 3 if three inputs are used) may be individually displayed via the  or  pushbutton.

In scanning mode the inputs are individually scanned and the display may be set to automatically scroll between channels at a user programmable rate. A standard inbuilt relay provides an alarm/control function, extra relays (up to 6 extra), serial communications, analog retransmission (single or dual channel) and excitation voltage may also be optionally provided. In scanning mode the display can be set to automatically scan between channels and/or to be manually scanned via the  or  pushbutton.

In both arithmetic and scanning modes each input used must be individually calibrated to read in the units required and any unused inputs disabled.

Unless otherwise specified at the time of order, your PM4 has been factory set to a standard configuration. Like all other PM4 series instruments the configuration and calibration is easily changed by the user. Initial changes may require dismantling the instrument to alter PCB links, other changes are made by push button functions.

Full electrical isolation between power supply, input voltage or current and retransmission output is provided by the PM4, thereby eliminating grounding and common voltage problems. This isolation feature makes the PM4 ideal for interfacing to computers, PLCs and other data acquisition devices. Note: the three input channels share a common ground. If this presents a problem, then separate analog isolators should be used.

This versatile PM4 has various front panel options, therefore in some cases the pushbuttons may be located on the front panel as well as the standard rear panel configuration.

The PM4 series of Panel Mount Monitors are designed for high reliability in industrial applications. The high brightness LED display provides good visibility, even in areas with high ambient light levels. The high contrast LCD displays provide good visibility and are ideal for battery powered applications.

1.2 Standard outputs

- A standard inbuilt relay provides an alarm/on/off control function.

1.3 Output options

- 1, 3 or 6 extra relays
- Isolated analog retransmission (single or dual analog output versions available) configurable for 4–20mA., 0–1V or 0–10V.
- ± 12 VDC (24V) isolated transmitter supply/excitation voltage (25mA max.).
- Isolated RS485 or RS232 serial communications (ASCII or Modbus RTU).
- Isolated Digital output - binary or BCD up to 16 bit, NPN or PNP output types available.
- Isolated Optional outputs are available in certain combinations e.g. Extra relay plus RS232.

2 Mechanical Installation

Choose a mounting position as far away as possible from sources of electrical noise such as motors, generators, fluorescent lights, high voltage cables/bus bars etc. An IP65 or IP67 access cover which may be installed on the panel and surrounds is available as an option to be used when mounting the instrument in damp/dusty positions. A wall mount case is available, as an option, for situations in which panel mounting is either not available or not appropriate. A portable carry case is also available, as an option, for panel mount instruments.

Prepare a panel cut out of 45mm x 92mm +1 mm / - 0 mm (see diagram below). Insert the instrument into the cut out from the front of the panel. From the rear of the instrument fit the two mounting brackets into the recess provided (see diagram below). Whilst holding the bracket in place, tighten the securing screws being careful not to over-tighten, as this may damage the instrument. Hint: use the elastic band provided to hold the mounting bracket in place whilst tightening securing screws.

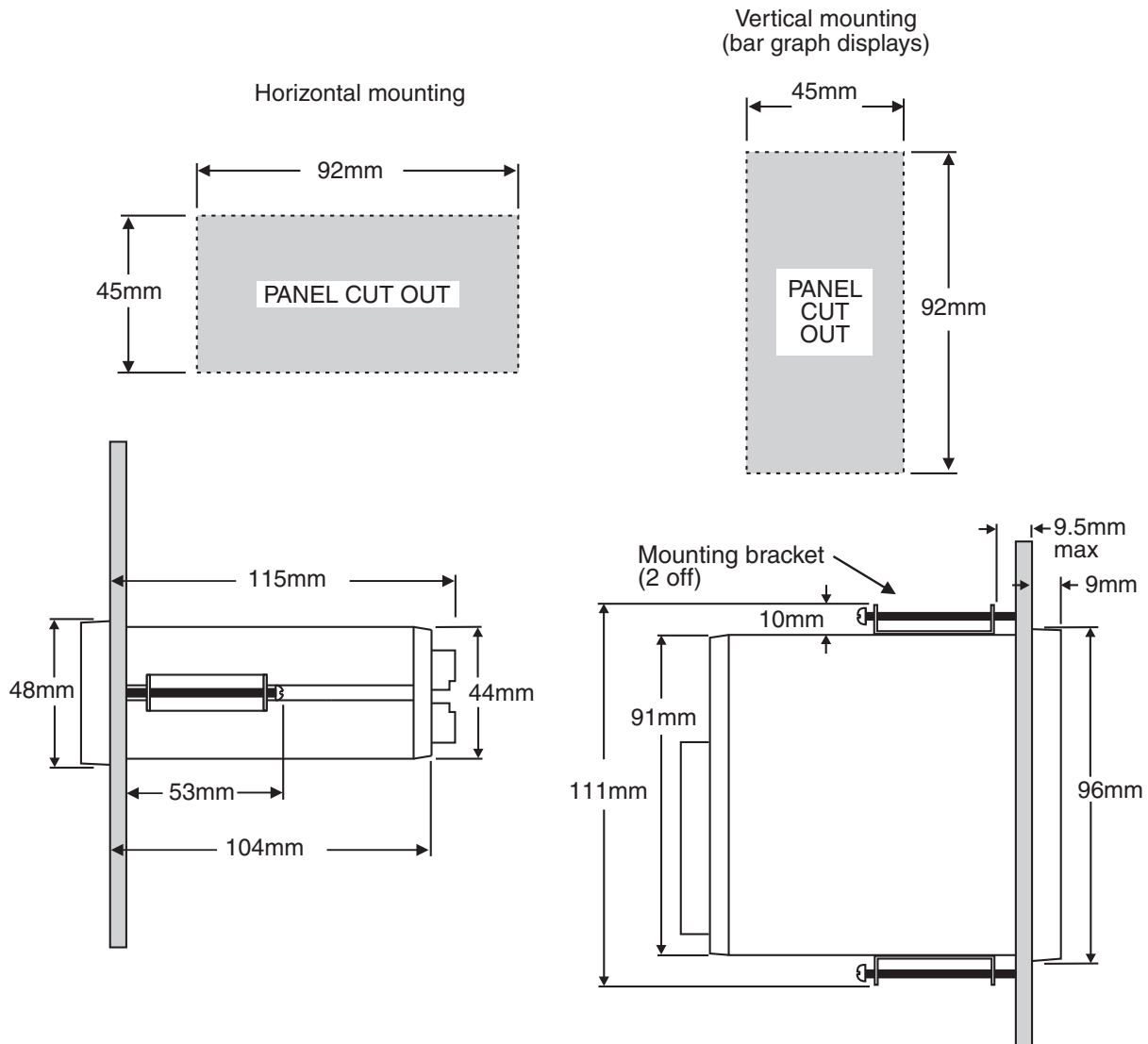

3 Electrical installation

3.1 Electrical installation

The PM4 Panel Meter is designed for continuous operation and no power switch is fitted to the unit. It is recommended that an external switch and fuse be provided to allow the unit to be removed for servicing.

The plug in, screw type, terminal blocks allow for wires of up to 2.5mm² to be fitted. Connect the wires to the appropriate terminals as indicated below. Refer to connection details provided in this chapter to confirm proper selection of voltage, polarity and input type before applying power to the instrument.

When power is applied the instrument will cycle through a display sequence indicating the software version and other status information, this indicates that the instrument is functioning. Acknowledgement of correct operation may be obtained by applying an appropriate input to the instrument and observing the reading. The use of screened cable is recommended for signal inputs.

For connection details of optional outputs refer to the separate "PM4 Panel Meter Optional Output Addendum" booklet supplied when options are fitted.

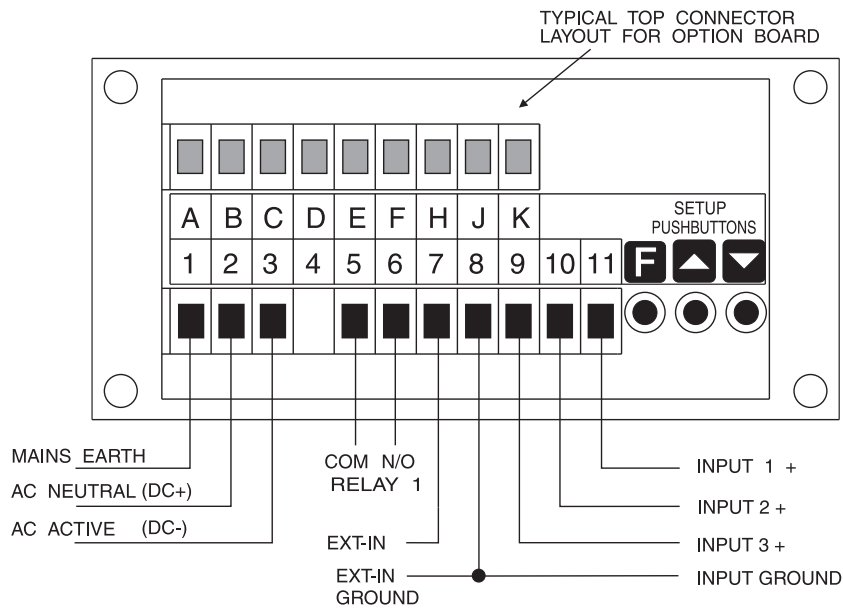

3.2 Electrical connection examples

If output options are fitted refer to the "PM4 Panel Meter Optional Output Addendum" booklet for connection details.

AC power connections - supply type is factory configured, check before connecting

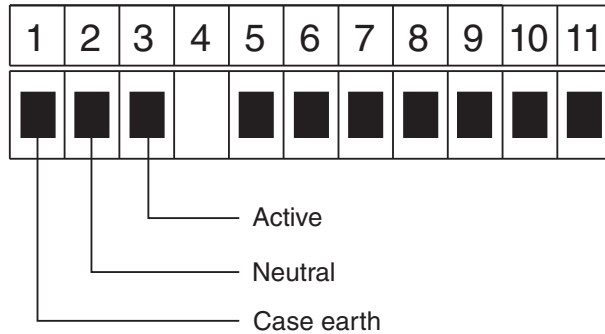

DC power connections (12 to 48VDC) - supply type is factory configured, check before connecting

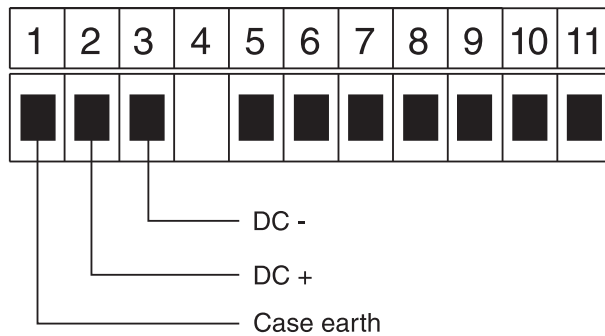

2 wire 4-20mA externally powered sensor connected to input 1

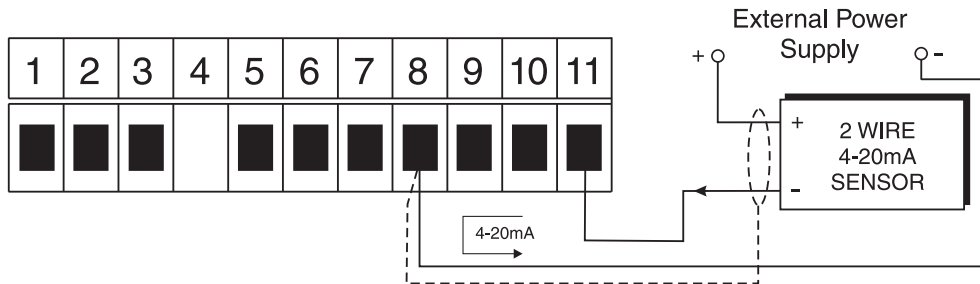

Two 2 wire 4-20mA externally powered sensors connected to inputs 1 and 2

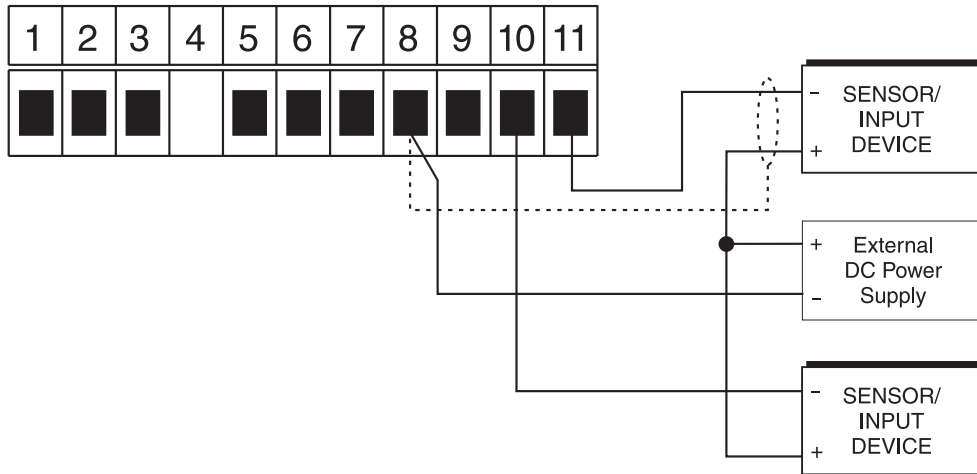

3 wire 4-20mA externally powered sensor connected to input 1

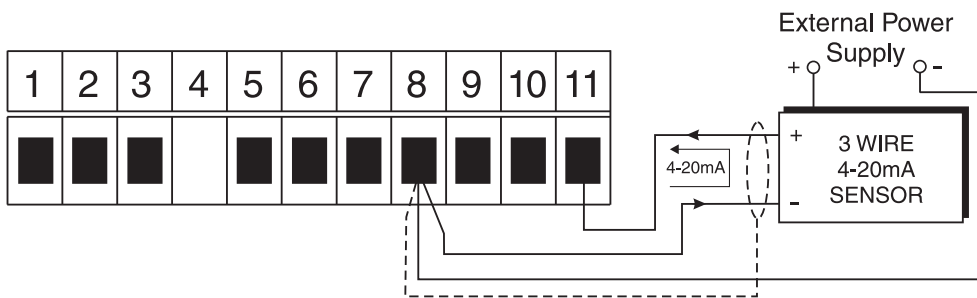

4 wire 4-20mA externally powered sensor connected to input 1

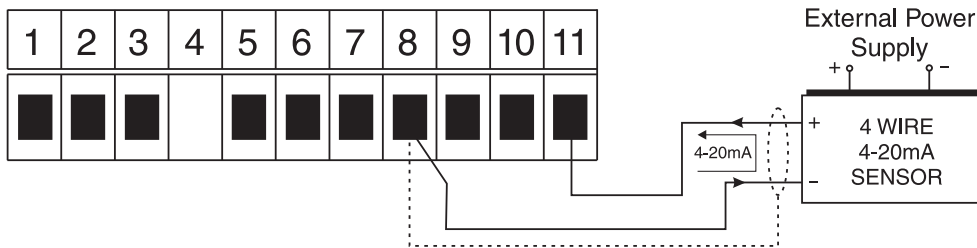

DC Volts input connected to input 1

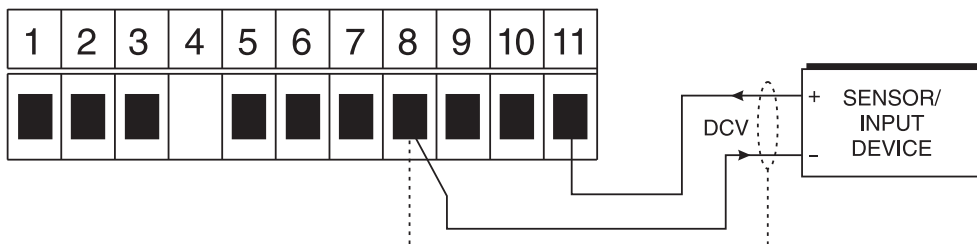

Remote input

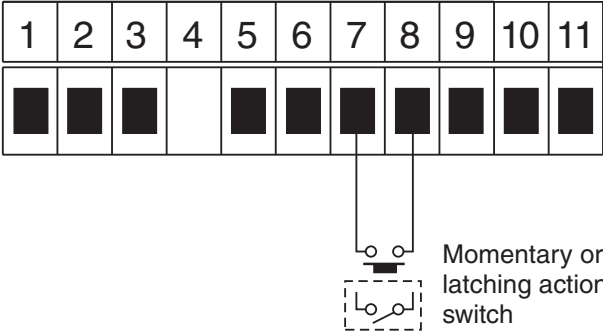

3.3 Input Output Configuration

If you need to alter the input or output configuration link settings proceed as follows:

1. Remove the plug in terminals from the rear of the instrument

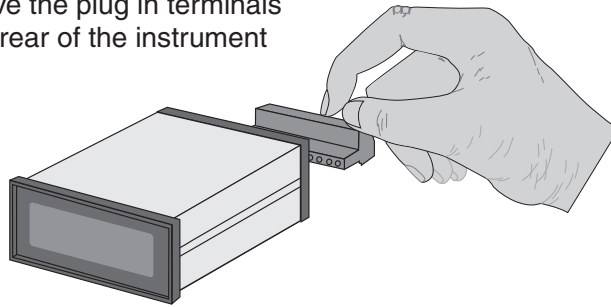

2. Remove the 4 x self tapping screws from the back cover then remove the back cover by pulling it away from the instrument

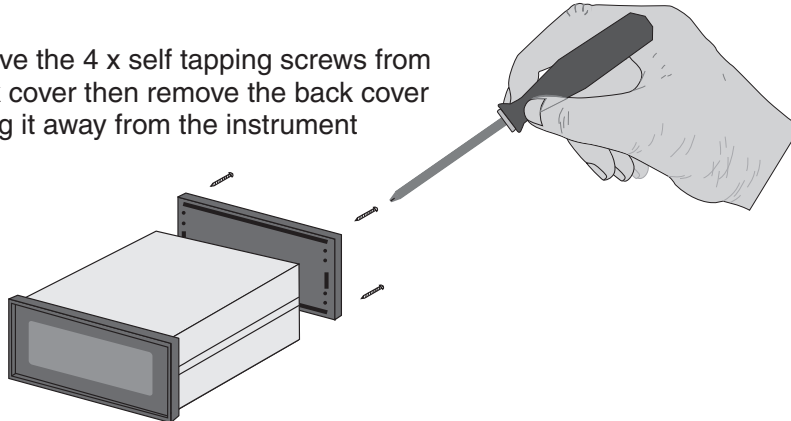

3. Remove the earth screw which passes through the underside of the case then slide out the board or boards

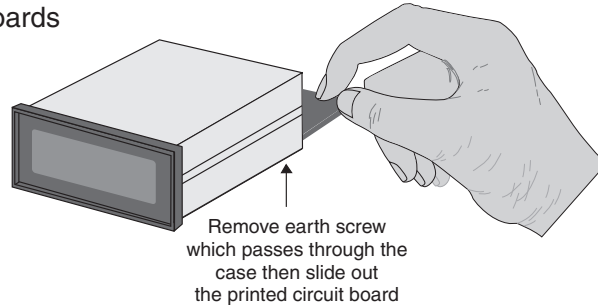

4. Configure the PCB links as required, see appropriate chapter
5. Slide PCB back into case
6. Replace the earth screw which passes through the case
7. Refit the back cover and fix with the self tapping screws
8. Plug the terminal strips back into the rear of the instrument

3.4 Input range link selection

Dismantle the instrument as described in section 3.3. Insert the links into the appropriate location on the pin header to suit the range required.

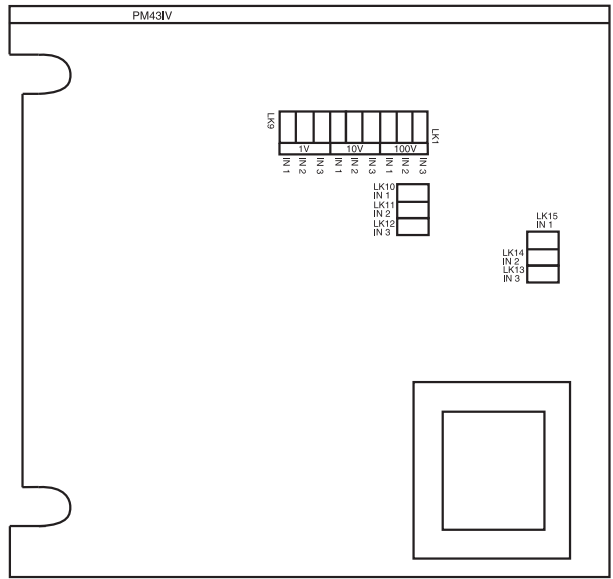

0 TO 1V RANGES SELECTED
CHANNELS 1, 2 & 3

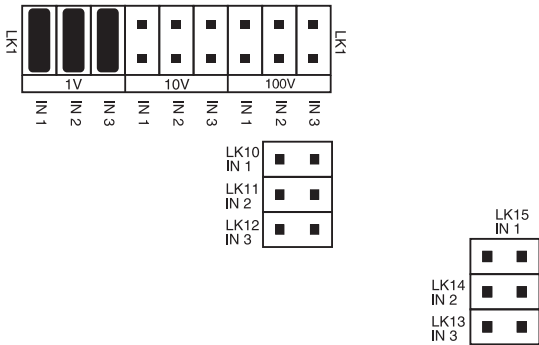

0 TO 10V RANGES SELECTED
CHANNELS 1, 2 & 3

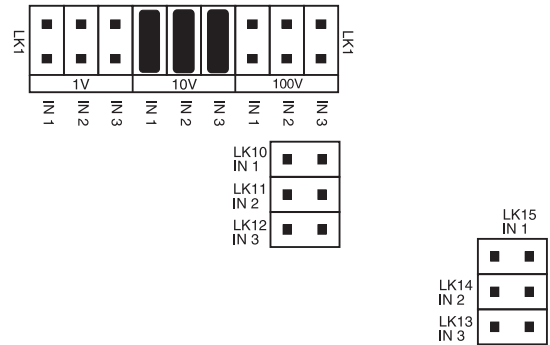

0 TO 100V RANGES SELECTED
CHANNELS 1, 2 & 3

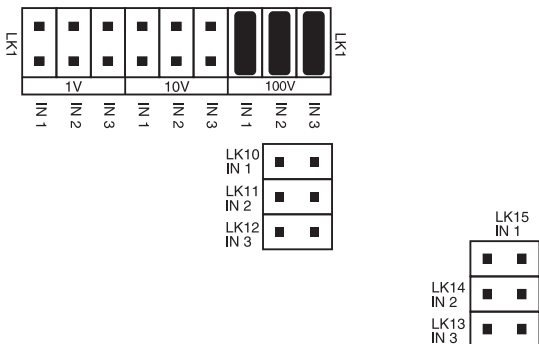

4 TO 20mA RANGES SELECTED
CHANNELS 1, 2 & 3

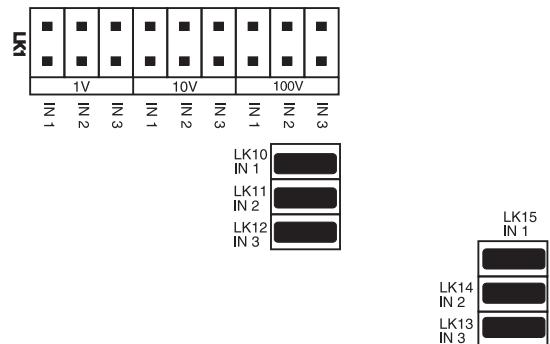

4 Function tables - summary of setup functions

Note: the order in which the functions appear on the display may not be exactly as shown below. The availability and order of functions is determined by choice of function settings and options fitted.

Functions in this first table are available in **FUNC** or **CAL** mode

Display	Function	Range	Default	Your record	Ref/Page
RxLo	Low setpoint value for designated alarm relay <i>x</i>	Any display value or OFF	OFF	See 4.1	5.1 / 19
RxHi	High setpoint value for designated alarm relay <i>x</i>	Any display value or OFF	OFF	See 4.1	5.2 / 19
RxHy	Hysteresis value for the designated alarm relay <i>x</i> .	0 to 9999	10	See 4.1	5.3 / 20
Rxtt	Trip time delay for the designated alarm relay <i>x</i> .	0 to 9999	0	See 4.1	5.4 / 20
Rxrt	Reset time delay for the designated alarm relay <i>x</i> .	0 to 9999	0	See 4.1	5.5 / 21
Rxn.o or Rxn.c	Alarm relay <i>x</i> action to normally open (de-energised) or normally closed (energised)	Rxn.o or Rxn.c	Rxn.o	See 4.1	5.6 / 21
RxSP or Rxt 1 etc.	Relay operation independent setpoint or trailing setpoint (*Optional)	RxSP or Rxt 1 etc.	RxSP	See 4.1	5.7 / 21
brgt	Display brightness level	1 to 15	15		5.8 / 22
dull	Display remote brightness switching	0 to 15	1		5.9 / 22
FEC-	Analog output option low display value (*Optional)	Any display value	0		5.10 / 22
FEC+	Analog output option high display value (*Optional)	Any display value	1000		5.11 / 23
FEC- Ch2	Second analog output option low display value (*Optional)	Any display value	0		5.12 / 23
FEC+ Ch2	Second analog output option high display value (*Optional)	Any display value	1000		5.13 / 23
bAr-	Bargraph low value (seen only on bargraph display instruments)	Any display value	0		5.14 / 23
bAr+	Bargraph high value (seen only on bargraph display instruments)	Any display value	1000		5.15 / 24

(*Optional)—this function will only be accessible if the relevant option is fitted

Functions in this second table are available only in **CAL** mode or if **ACCS** is set to **ALL**

Display	Function	Range	Default	Your record	Ref/Page
bAr tYPE	Bargraph type for instruments with bargraph display (seen only on bargraph display instruments)	bAr , S.dot , d.dot , C.bAr or r.dot	bAr		5.16 / 24
bAr OPER	Bargraph display operation mode	ArEH.CH1 , CH2 or CH3	ArEH		5.17 / 25
d9OP	Digital output option mode (*Optional)	bcd , b.SCL , b,n or b,n2	b,n2		5.18 / 25
d9.OP	Digital output option polarity (*Optional)	RI 0 or RI 1	RI 0		5.19 / 26
bcd Start	Digital output option BCD start position (*Optional)	0 , 1 or 2	0		5.20 / 26
d, 9-	Digital output option low value (*Optional)	Any display value	0		5.21 / 26
d, 9+	Digital output option high value (*Optional)	Any display value	1000		5.22 / 26
dRnd	Display rounding	1 to 5000	1		5.23 / 27
dCPt	Decimal point for arithmetic operation	0 , 0.1 etc.	0		5.24 / 27
FLtr	Digital filter	0 to 8	2		5.25 / 27
Chno.	Number of active channels	1 to 3	3		5.26 / 28
Ch1 dCPt	Decimal point for channel 1	0 , 0.1 etc.	0		5.27 / 28
Ch2 dCPt	Decimal point for channel 2	0 , 0.1 etc.	0		5.28 / 28
Ch3 dCPt	Decimal point for channel 3	0 , 0.1 etc.	0		5.29 / 28
EA1	EA1 value for arithmetic formula	-32727 to 32767	1		5.30 / 29
Eb1	Eb1 value for arithmetic formula	-32727 to 32767	0		5.31 / 29
EC1	EC1 value for arithmetic formula	-32727 to 32767	1		5.32 / 29
EA2	EA2 value for arithmetic formula	-32727 to 32767	1		5.33 / 29
Eb2	Eb2 value for arithmetic formula	-32727 to 32767	0		5.34 / 30
EC2	EC2 value for arithmetic formula	-32727 to 32767	1		5.35 / 30
EA3	EA3 value for arithmetic formula	-32727 to 32767	1		5.36 / 30

(*Optional)—this function will only be accessible if the relevant option is fitted

Eb3	Eb3 value for arithmetic formula	-32727 to 32767	0		5.37 / 30
EC3	EC3 value for arithmetic formula	-32727 to 32767	1		5.38 / 30
OP1	Arithmetic operation between channels 1 and 2	Add, Sub, Prod, d, U, H, Gh, Lo, Si NE, COS or d, FF	Add		5.39 / 31
OP2	Arithmetic operation between channel 3 and previous operation	Add, Sub, Prod, d, U, H, Gh, Lo, Si NE, COS or d, FF	Add		5.40 / 31
Ch0	Channel 0 polarity	both, POS or NEG	both		5.41 / 32
Ch1	Channel 1 polarity	both, POS or NEG	both		5.42 / 32
Ch2	Channel 2 polarity	both, POS or NEG	both		5.43 / 32
Ch3	Channel 3 polarity	both, POS or NEG	both		5.44 / 32
Ch1 CAL1	First calibration scaling point for channel 1 input	Any display value	n/a		5.45 / 32
Ch1 CAL2	Second calibration scaling point for channel 1 input	Any display value	n/a		5.46 / 33
Ch2 CAL1	First calibration scaling point for channel 2 input	Any display value	n/a		5.47 / 33
Ch2 CAL2	Second calibration scaling point for channel 2 input	Any display value	n/a		5.48 / 33
Ch3 CAL1	First calibration scaling point for channel 3 input	Any display value	n/a		5.49 / 33
Ch3 CAL2	Second calibration scaling point for channel 3 input	Any display value	n/a		5.50 / 33
UCAL Ch1	Uncalibrate channel 1	n/a	n/a		5.51 / 33
UCAL Ch2	Uncalibrate channel 2	n/a	n/a		5.52 / 34
UCAL Ch3	Uncalibrate channel 3	n/a	n/a		5.53 / 34
P.but	P button function	NONE, H, ., Lo, Hi, Lo or ZERO	NONE		5.54 / 34

(*Optional)—this function will only be accessible if the relevant option is fitted

R.I NP	Remote input (external input) function	NONE . P.HLd . d.HLd.H . Lo.H.Lo . ZERO . SP.Ac.No.Ac or dULL	NONE		5.55 / 34
ACCESS	Access mode	OFF.EASY . NONE or ALL	OFF		5.56 / 35
SPAC	Setpoint access mode (*Optional)	A1.A1-2 etc.	A1		5.57 / 36
A1 OPER, A2 OPER etc.	Alarm relay channel allocation	Arth, Ch1, Ch2 or Ch3	Arth		5.58 / 36
SCAN PERd	Scan period	0 to 240	0		5.59 / 36
FEC OPER	First analog output operation mode (*Optional)	Arth, Ch1, Ch2, Ch3, HIGH, Lo, RUSE, S.PLS or S.FLY	Ch1		5.60 / 36
FEC PLSE	First analog output pulse width (*Optional)	0 to 10	0		5.61 / 38
FEC2 OPER	Second analog output operation mode (*Optional)	Arth, Ch1, Ch2, Ch3, HIGH, Lo, RUSE, S.PLS or S.FLY	Ch1		5.62 / 38
FEC2 PLSE	Second analog output pulse width (*Optional)	0 to 10	0		5.63 / 39
SEt OPER	Set operation mode	Arth or SCAN	Arth		5.64 / 39
BAUD RATE	Baud rate for serial communications (*Optional)	300.600 . 1200.2400 . 4800.9600 . 19.2 or 38.4	9600		5.65 / 39
Prty	Parity for serial communications (*Optional)	NONE.EVEN or odd	NONE		5.66 / 39
OPUt	Output for serial communications (*Optional)	di SP.Cont . POLL, R.buS or ā.buS	Cont		5.67 / 39
Addr	Instrument address for serial communications (*Optional)	0 to 31	0		5.68 / 40

(*Optional)—this function will only be accessible if the relevant option is fitted

4.1 Relay table

Record your relay settings in the table below

Display	Relay 1	Relay 2	Relay 3	Relay 4	Relay 5	Relay 6	Relay 7
<i>AxLo</i>							
<i>AxH.</i>							
<i>AxHY</i>							
<i>Axtt</i>							
<i>Axrt</i>							
<i>Axn.o</i> or <i>Axn.c</i>							
<i>AxSP</i> or <i>Axt 1</i> etc.	n/a						
<i>Ax OPEF</i>							

5 Explanation of functions

The PM4 setup and calibration functions are configured through a push button sequence. The three push buttons located at the rear of the instrument (also at the front on some display options) are used to alter settings. Two basic access modes are available:

FUNC mode (simple push button sequence) allows access to commonly set up functions such as alarm setpoints.

CAL mode (power up sequence plus push button sequence) allows access to all functions including calibration parameters.

Once **CAL** or **FUNC** mode has been entered you can step through the functions, by pressing and releasing the **F** push button, until the required function is reached. Changes to functions are made by pressing the or push button (in some cases both simultaneously) when the required function is reached. See the flow chart example on the following page.

Entering CAL Mode



1. Remove power from the instrument. Hold in the **F** button and reapply power. The display will briefly indicate **CAL** as part of the "wake up messages" when the **CAL** message is seen you can release the button. Move to step 2 below.



2. When the "wake up" messages have finished and the display has settled down to its normal reading press, then release the **F** button. Move to step 3 below.

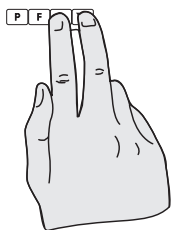

3. Within 2 seconds of releasing the **F** button press, then release the **▲** and **▼** buttons together. The display will now indicate **FUNC** followed by the first function.

Note: If step 1 above has been completed then the instrument will remain in this **CAL** mode state until power is removed. i.e. there is no need to repeat step 1 when accessing function unless power has been removed.

Entering FUNC Mode

No special power up procedure is required to enter **FUNC** mode.



1. When the "wake up" messages have finished and the display has settled down to its normal reading press, then release the **F** button.



2. Within 2 seconds of releasing the **F** button press, then release the **▲** and **▼** buttons together. The display will now indicate **FUNC** followed by the first function.

Example: Entering **FUNC** mode to change alarm 1 high function **A 1H**, from **OFF** to **100**

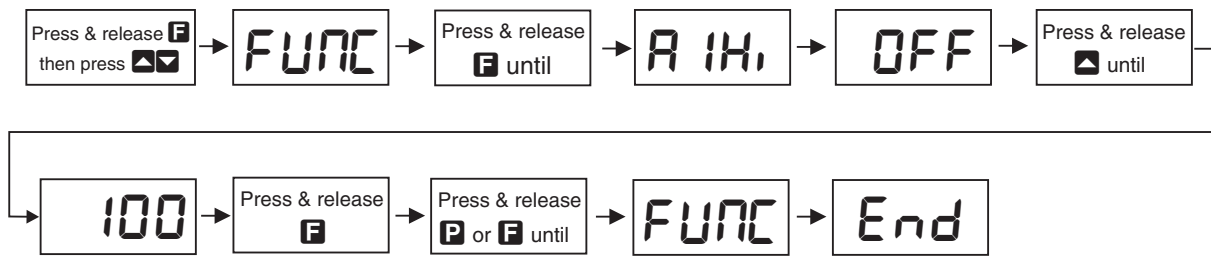

Example: Entering **CAL** mode to change decimal point function **dCPT** from **0** to **0.02**

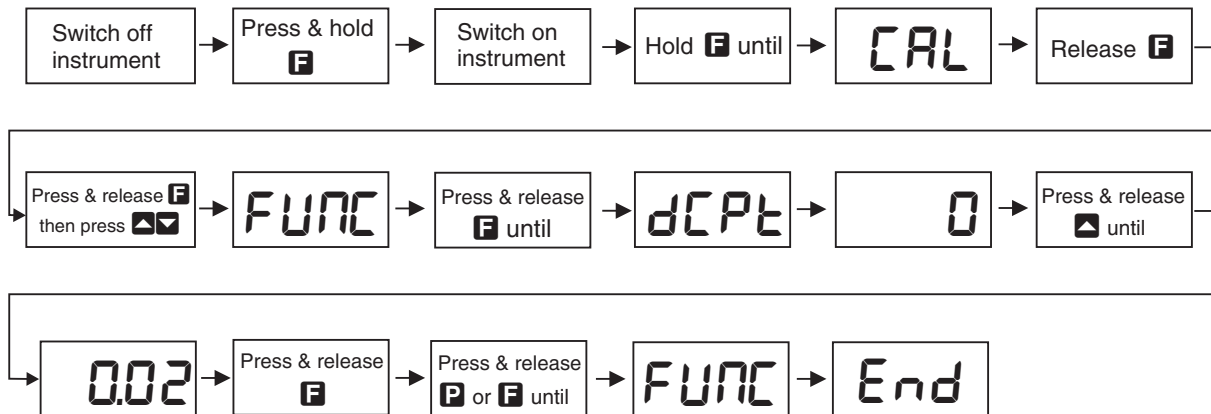

Easy alarm relay adjustment access facility

The display has an easy alarm access facility which allows access to the alarm setpoints simply by pressing the **F** button at the front or rear of the instrument. The first setpoint will then appear and changes to this setpoint may be made to this setpoint via the **▲** or **▼** buttons. Press the **F** button to accept any changes or to move on to the next setpoint. Note: this easy access also functions in the same manner for the PI control setpoint (relay and/or analog PI output) if PI control is available. The instrument must be set in the manner described below to allow the easy access facility to work:

1. The **PI OP** function must be set to **SPAC** or the **ACCS** function must be set to **EASY**.
2. At least one alarm must have a setpoint, nothing will happen if all the alarm setpoints are set to **OFF**.
3. The **SPAC** function must be set to allow access to the relays required e.g. if set to **A 1-2** then the easy access will work only with alarm relays 1 and 2 even if more relays are fitted.
4. The instrument must be in normal measure mode i.e. if the instrument is powered up so that it is in **CAL** mode then the easy access will not function. If in doubt remove power from the instrument, wait for a few seconds then apply power again.
5. If the easy access facility is used then the only way to view or alter any other function settings is to power up via **CAL** mode i.e. there is no entry to **FUNC** mode functions unless the instrument is powered up in **CAL** mode.

Explanation of Functions

5.1 Alarm relay low setpoint

Display: $RxLo$
Range: Any display value or **OFF**
Default Value: **OFF**

Displays and sets the low setpoint value for the designated alarm relay x . Note x will be replaced by the relay number when displayed e.g. $R1Lo$ for relay 1. Use this low setpoint function if a relay operation is required when the display value becomes equal to or less than the low setpoint value. To set a low alarm value go to the $RxLo$ function and use the \blacktriangle or \blacktriangledown push buttons to set the value required then press **F** to accept this value. The low alarm setpoint may be disabled by pressing the \blacktriangle and \blacktriangledown push buttons simultaneously. When the alarm is disabled the display will indicate **OFF**. If the relay is allocated both a low and high setpoint then the relay will activate when the value displayed moves outside the band set by the low and high setpoints. The value at which the relay will reset is controlled by the $RxHy$ function.

Example:

If $R1Lo$ is set to **10** then relay 1 will activate when the display value is 10 or less.

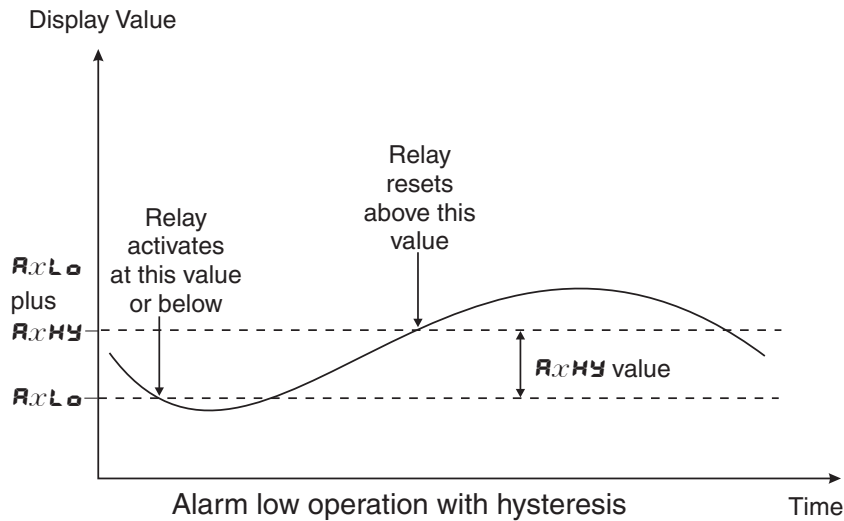

5.2 Alarm relay high setpoint

Display: RxH ,
Range: Any display value or **OFF**
Default Value: **OFF**

Displays and sets the high setpoint value for the designated alarm relay x . Note x will be replaced by the relay number when displayed e.g. $R1H$, for relay 1. Use this high setpoint function if a relay operation is required when the display value becomes equal to or more than the low setpoint value. To set a high alarm value go to the RxH , function and use the \blacktriangle or \blacktriangledown push buttons to set the value required then press **F** to accept this value. The high alarm setpoint may be disabled by pressing the \blacktriangle and \blacktriangledown push buttons simultaneously. When the alarm is disabled the display will indicate **OFF**. If the relay is allocated both a low and high setpoint then the relay will activate when the value displayed moves outside the band set by the low and high setpoints. The value at which the relay will reset is controlled by the $RxHy$ function.

Example:

If **A 1H** is set to **100** then relay 1 will activate when the display value is **100** or higher.

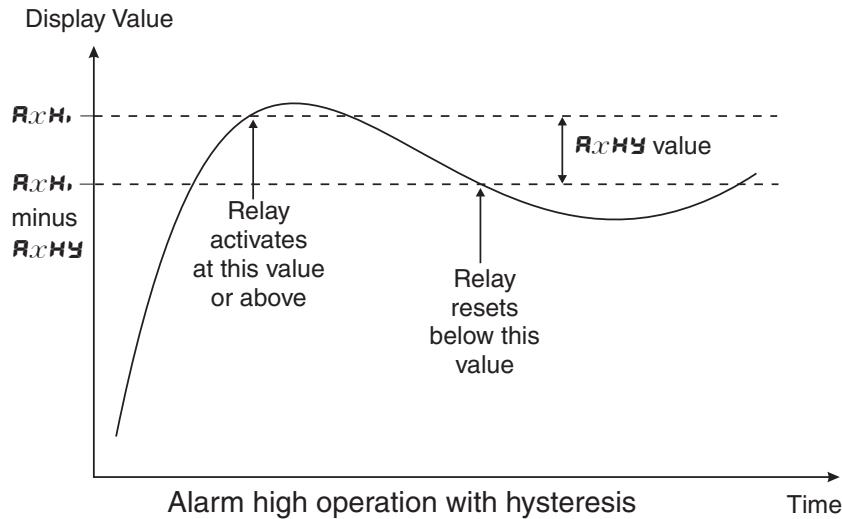

5.3 Alarm relay hysteresis (deadband)

Display: **R x H Y**
 Range: **0** to **9999**
 Default Value: **10**

Displays and sets the alarm relay hysteresis limit for the designated relay *x*. Note *x* will be replaced by the relay number when displayed e.g. **A 1H Y** for relay 1. To set a relay hysteresis value go to the **A x H Y** function and use the **▲** or **▼** push buttons to set the value required then press **F** to accept this value. The hysteresis value is common to both high and low setpoint values. The hysteresis value may be used to prevent too frequent operation of the relay when the measured value is rising and falling around setpoint value. e.g. if **A 1H Y** is set to zero the alarm will activate when the display value reaches the alarm setpoint (for high alarm) and will reset when the display value falls below the setpoint, this can result in repeated on/off switching of the relay at around the setpoint value.

The hysteresis setting operates as follows: In the high alarm mode, once the alarm is activated the input must fall below the setpoint value minus the hysteresis value to reset the alarm. e.g. if **A 1H** is set to **50.0** and **A 1H Y** is set to **3.0** then the setpoint output relay will activate once the display value goes to **50.0** or above and will reset when the display value goes below **47.0** i.e. at **46.9** or below. In the low alarm mode, once the alarm is activated the input must rise above the setpoint value plus the hysteresis value to reset the alarm. e.g. if **A 1L** is to **20.0** and **A 1H Y** is set to **10.0** then the alarm output relay will activate when the display value falls to **20.0** or below and will reset when the display value goes above **30.0** i.e. at **30.1** or above. The hysteresis units are expressed in displayed engineering units.

Example: If **A 1H** is set to **100** and **A 1H Y** is set to **10** then relay 1 will activate when the display value is **100** or higher and will reset at a display value of **89** or lower.

5.4 Alarm relay trip time

Display: **R x t t**
 Range: **0** to **9999**
 Default Value: **0**

Displays and sets the alarm trip time in seconds. The trip time is common for both alarm high and

low setpoint values. The trip time provides a time delay before the alarm relay will activate when an alarm condition is present. The alarm condition must be present continuously for the whole trip time period before the alarm will activate. If the input moves out of alarm condition during this period the timer will reset and the full time delay will be restored. This trip time delay is useful for preventing an alarm trip due to short non critical deviations from setpoint. The trip time is selectable over 0 to 9999 seconds. To set a trip time value go to the **AxTt** function and use the **▲** or **▼** push buttons to set the value required then press **F** to accept this value.

Example: If **A1Tt** is set to **5** seconds then the display must indicate an alarm value for a full 5 seconds before relay 1 will activate.

5.5 Alarm relay reset time

Display: **Axrt**
Range: **0** to **9999**
Default Value: **0**

Displays and sets the alarm reset delay time in seconds. The reset time is common for both alarm high and low setpoint values. With the alarm condition is removed the alarm relay will stay in its alarm condition for the time selected as the reset time. If the input moves back into alarm condition during this period the timer will reset and the full time delay will be restored. The reset time is selectable over 0 to 9999 seconds. To set a reset time value go to the **Axrt** function and use the **▲** or **▼** push buttons to set the value required then press **F** to accept this value.

Example: If **A1rt** is set to **10** seconds then the resetting of alarm relay 1 will be delayed by 10 seconds.

5.6 Alarm relay normally open/closed

Display: **Axn.o** or **Axn.c**
Range: **Axn.o** or **Axn.c**
Default Value: **Axn.o**

Displays and sets the setpoint alarm relay *x* action to normally open (de-energised) or normally closed (energised), when no alarm condition is present. Since the relay will always open when power is removed a normally closed alarm is often used to provide a power failure alarm indication. To set the alarm relay for normally open or closed go to the **Axn.o** or **Axn.c** function and use the **▲** or **▼** push buttons to set the required operation then press **F** to accept this selection. **Example:** If set to **A1n.o** alarm relay 1 will be open circuit when the display is outside alarm condition and will be closed (short circuit across terminals) when the display is in alarm condition.

5.7 Alarm relay setpoint or trailing operation

Display: **AxSP** or **Axt i** etc.
Range: **AxSP** or **Axt i** etc.
Default Value: **AxSP**

Relay operation independent setpoint or trailing setpoint, this function only be seen where more than one relay is fitted. Each alarm relay, except relay 1, may be programmed to operate with an independent setpoint value or may be linked to operate at a fixed difference to another relay setpoint, known as trailing operation. The operation is as follows:

Alarm 1 (**A1**) is always independent. Alarm 2 (**A2**) may be independent or may be linked to Alarm 1. Alarm 3 (**A3**) may be independent or may be linked to Alarm 1 or Alarm 2. Alarm 4 (**A4**) may be independent or may be linked to Alarm 1, Alarm 2 or Alarm 3. The operation of each alarm is selectable by selecting, for example, (Alarm 4) **A4.SP** = Alarm 4 normal setpoint or **A4.t1** = Alarm 4 trailing Alarm 1 or **A4.t2** = Alarm 4 trailing Alarm 2 or **A4.t3** = Alarm 4 trailing Alarm 3. For trailing set points the setpoint value is entered as the difference from the setpoint being trailed. If the trailing setpoint is to operate ahead of the prime setpoint then the value is entered as a positive number and if operating behind the prime setpoint then the value is entered as a negative number.

Example: With Alarm 2 set to trail alarm 1, if **A1H** is set to **1000** and **A2H** is set to **50** then Alarm 1 will activate at **1000** and alarm 2 will activate at **1050** (i.e. 1000 + 50). If Alarm 2 had been set at **-50** then alarm 2 would activate at **950** (i.e. 1000 - 50).

5.8 Display brightness

Display: **br9t**
Range: **1** to **15**
Default Value: **15**

Displays and sets the digital display brightness. The display brightness is selectable from **1** to **15**, where **1** = lowest intensity and **15** = highest intensity. This function is useful for improving the display readability in dark areas or to reduce the power consumption of the instrument. See also the **dull** function. To set brightness level go to the **br9t** function and use the **▲** or **▼** push buttons to set the value required then press **F** to accept this value.

5.9 Display remote brightness switching

Display: **dull**
Range: **0** to **15**
Default Value: **1**

Displays and sets the level for remote input brightness switching, see **r.inp** function. When a remote input is set to **dull** the remote input can be used to switch between the display brightness level set by the **br9t** function 5.8 and the display brightness set by the **dull** function. The display dull level is selectable from **0** to **15**, where **0** = lowest intensity and **15** = highest intensity. This function is useful in reducing glare when the display needs to be viewed in both light and dark ambient light levels. To set dull level go to the **dull** function and use the **▲** or **▼** push buttons to set the value required then press **F** to accept this value.

Example: With **dull** set to **4** and **br9t** set to **15** and the **r.inp** function set to **dull** the display brightness will change from the **15** level to **4** when a switch connected to the remote input terminals is activated.

5.10 Analog output option low value

Display: **FEC_**
Range: Any display value
Default Value: **0**

Seen only when analog retransmission option fitted. Refer to the separate “PM4 Panel Meter Optional Output Addendum” booklet supplied when this option is fitted for wiring details and link

settings. Displays and sets the analog retransmission (4–20mA, 0–1V or 0–10V, link selectable) output low value (4mA or 0V) in displayed engineering units. To set the analog output low value go to the **FEE-** function and use the **▲** or **▼** push buttons to set the required value then press **F** to accept this selection.

Example: If it is required to retransmit 4mA when the display indicates **0** then select **0** in this function using the **▲** or **▼** button.

5.11 Analog output option high value

Display: **FEE⁻**
Range: Any display value
Default Value: **1000**

Seen only when analog retransmission option fitted. Refer to the separate “PM4 Panel Meter Optional Output Addendum” booklet supplied when this option is fitted for wiring details and link settings. Displays and sets the analog retransmission (4–20mA, 0–1V or 0–10V, link selectable) output high display value (20mA, 1V or 10V) in displayed engineering units. To set the analog output high value go to the **FEE⁻** function and use the **▲** or **▼** push buttons to set the required value then press **F** to accept this selection.

Example: If it is required to retransmit 20mA when the display indicates **50** then select **50** in this function using the **▲** or **▼** button.

5.12 Second analog output option low value

Display: **FEE- CH2**
Range: Any display value
Default Value: **0**

See **FEE-** function 5.10 for description of operation.

5.13 Second analog output option high value

Display: **FEE⁻ CH2**
Range: Any display value
Default Value: **1000**

See **FEE⁻** function 5.11 for description of operation.

5.14 Bargraph low value

Display: **BAR-**
Range: Any display value
Default Value: **0**

Seen only in bargraph display instruments. Displays and sets the bar graph low value i.e. the value on the 7 segment display at which the bargraph will start to rise. This may be independently set anywhere within the display range of the instrument. Note: The **BAR-** and **BAR⁻** settings are referenced from the 7 segment display readings, not the bargraph scale values. The bargraph scale may be scaled differently to the 7 segment display. For example the bargraph scale may be indicating

percentage fill of a tank whilst the 7 segment display is indicating actual process units. To set bargraph low level go to the **bAr-** function and use the ▲ or ▼ push buttons to set the value required then press **F** to accept this value.

5.15 Bargraph high value

Display: **bAr⁻**
 Range: Any display value
 Default Value: **1000**

Seen only in bargraph display instruments. Displays and sets the bar graph high value i.e. the value on the 7 segment display at which the bargraph will reach its maximum indication (e.g. all LEDs illuminated). May be independently set anywhere within the display range of the instrument. To set bargraph high level go to the **bAr⁻** function and use the ▲ or ▼ push buttons to set the value required then press **F** to accept this value.

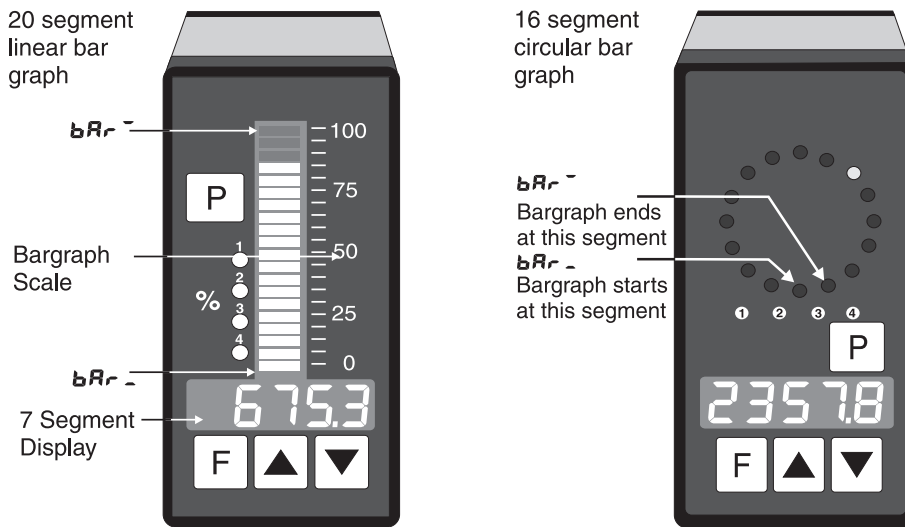

5.16 Bargraph type for instruments with bargraph display

Display: **bAr TYPE**
 Range: **bAr**, **S.dot**, **d.dot**, **C.bAr** or **r.dot**
 Default Value: **bAr**

Bar graph display operation mode - seen only in vertical or circular bargraph display instruments. Allows selection of bargraph operation mode. Choices available are:

- **bAr** - conventional solid bargraph display i.e. all LEDs illuminated when at full scale. When scaling the display use the **bAr-** and **bAr⁻** functions e.g. **bAr- = 0** and **bAr⁻ = 100** will give a bargraph with no segments lit at a 7 segment display reading of **0** and all segments lit with a 7 segment display reading of **100**.
- **S.dot** - single dot display. A single segment will be lit to indicate the input readings position on the scale. When scaling the display use the **bAr-** and **bAr⁻** functions e.g. **bAr- = 0** and **bAr⁻ = 100** will give a bargraph with the bottom segment lit at a 7 segment display reading of **0** and the top segment lit with a 7 segment display reading of **100**. Note: this could also be set up as a centre zero single dot display by entering a negative value and positive value. e.g. **bAr- = -100**, **bAr⁻ = 100**.

- **d.dot** - double dot display. Two segments will be lit to indicate the input reading position on the scale. The reading should be taken from the middle of the two segments. When scaling the display use the **bAr₊** and **bAr₋** functions e.g. **bAr₊ = 0** and **bAr₋ = 100** will give a bargraph with the bottom two segments lit at a 7 segment display reading of **0** and the top two segments lit with a 7 segment display reading of **100**. Note: this could also be set up as a centre zero double dot display by entering a negative value and positive value. e.g. **bAr₊ = -100**, **bAr₋ = 100**.
- **C.bAr** - centre bar display. The display will be a solid bargraph but will have its zero point in the middle of the display. If the seven segment display value is positive the bargraph will rise. If the seven segment display value is negative then the bargraph will fall. When scaling the display use the **bAr₊** and **bAr₋** functions e.g. **bAr₊ = 0** and **bAr₋ = 100** will give a bargraph with all the bottom half segments lit at a 7 segment display reading of **-100** and all the top segments lit with a 7 segment display reading of **100**.
- **r.dot** - modulus or wrap around single dot bargraph. This mode of operation allows the bargraph to wrap around the limits set by the **bAr₊** and **bAr₋** functions by dividing the 7 segment display by the modulus (the modulus is the difference between 0 and **bAr₋**) and displaying the remainder. For example if **bAr₊** is set to **0** and **bAr₋** is set to **10** then in other bargraph modes when the 7 segment display reads a value such as **25** the bargraph would be stuck at the high limit of its travel since it cannot go beyond **10**. In **r.dot** mode the display will wrap around at **10** then continue up the bar again and will be at the midpoint of the bargraph when the 7 segment display shows **25** (as it would for a 7 segment display of **15**, **35**, etc.). In this example for a 7 segment display of **25** the value of 25 is divided by the modulus value of 10 in this example and the remainder displayed i.e. 10 goes into 25 twice with the remainder of 5 and so a bargraph position of 5 is displayed. This mode will operate on both vertical and circular bargraph type displays.

5.17 Bargraph display operation mode

Display: **bAr OPEr**
 Range: **ArLH.CH1.CH2** or **CH3**
 Default Value: **ArLH**

Seen only in bargraph model displays. Allows the choice of the arithmetic result (**ArLH**), channel 1 (**CH1**), channel 2 (**CH2**) or channel 3 (**CH3**) value to be displayed on the bargraph. Note the choice of **ArLH** should only be used if the **SEt OPEr** function is also set to **ArLH** i.e. when the display is set to operate in arithmetic mode.

5.18 Digital output option mode

Display: **d90P**
 Range: **bcd**, **b.SCL**, **b, n** or **b, n2**
 Default Value: **b, n2**

Seen only with the 16 bit digital output option. Refer to the separate “PM4 Panel Meter Optional Output Addendum” booklet supplied when this option is fitted. Selections available are: **b, n2** (signed binary) i.e. -32767 to 32767, **b, n** (unsigned binary) i.e. 0 to 65535, **b.SCL** (scaled binary, see **d, 9₊** and **d, 9₋** below), **bcd** (binary coded decimal) i.e. up to four BCD numbers. Note: the digital output will retransmit the arithmetic result (channel 0) only and so should only be used when the **SEt OPEr** function is set to **ArLH**.

5.19 Digital output option polarity

Display: **d9.OP**
Range: **AL 0** or **AH,**
Default Value: **AL 0**

Seen only with the 16 bit digital output option. Refer to the separate “PM4 Panel Meter Optional Output Addendum” booklet supplied when this option is fitted. Selections available are: **AL 0** (active low i.e. logic 1 = 0V output, logic 0 = +V output) or **AH,** (active high i.e. logic 1 = +V output, logic 0 = 0V output).

5.20 Digital output option BCD start position

Display: **bcd Start**
Range: **0, 1** or **2**
Default Value: **0**

Seen only with the 16 bit digital output option. Refer to the separate “PM4 Panel Meter Optional Output Addendum” booklet supplied when this option is fitted. This function affects BCD mode only and determines the number of digits to skip when outputting from the display. As the output is 16 bit it can output up to 4 BCD numbers. Select from **0** to number of display digits minus 4. e.g. for a 6 digit display you may select **0** to **2**, if **2** is selected then the four left most digits will be output, if set to **0** then the four right most digits will be output.

5.21 Digital output option low value

Display: **d, 9-**
Range: Any display value
Default Value: **0**

Seen only with the 16 bit digital output option. Refer to the separate “PM4 Panel Meter Optional Output Addendum” booklet supplied when this option is fitted. Accepts any valid display value. Determines the low scaling point for the **b.5CL** mode and has no effect on other modes. See example which follows in 5.22.

5.22 Digital output option high value

Display: **d, 9^**
Range: Any display value
Default Value: **1000**

Seen only with the 16 bit digital output option. Refer to the separate “PM4 Panel Meter Optional Output Addendum” booklet supplied when this option is fitted. Determines the high scaling point for the **b.5CL** mode and has no effect on other modes.

Example: If **d, 9-** is set to **0** and **d, 9^** is set to **65535** ($2^{16} - 1$) then the retransmission will not be scaled i.e. a display of **2** will cause a retransmission of 2. If **d, 9^** is now changed to **32767** ($2^{15} - 1$) then a display of **2** will cause a retransmission of 4 (note: rounding may occur on retransmission).

5.23 Display rounding

Display: **drnd**
Range: **1** to **5000**
Default Value: **1**

Displays and sets the display rounding value. This value may be set to 1 - 5000 displayed units. Display rounding is useful for reducing the instrument resolution without loss of accuracy in applications where it is undesirable to display to a fine tolerance. To set the display rounding value go to the **drnd** function and use the **▲** or **▼** push buttons to set the required value then press **F** to accept this selection.

Example: If set to **10** the display values will change in multiples of 10 only i.e. display moves from **10** to **20** to **30** etc.

5.24 Decimal point for arithmetic operation

Display: **dCpt**
Range: **0**, **0.1** etc.
Default Value: **0**

Displays and sets the decimal point for the arithmetic result, this function only applies when the **SEt OPER** function is set to **Arth**. By pressing the **▲** or **▼** pushbutton at the **dCpt** function the decimal point position may be set. The display will indicate as follows: **0** (no decimal point), **0.1** (1 decimal place), **0.02** (2 decimal places) etc. up to 5 decimal places. Note if the decimal point is altered the display will need to be recalibrated and alarm etc. settings checked. The arithmetic calculation will assume that all channel decimal places are the same as the arithmetic channel e.g. a channel 1, 2 or 3 display of **1.00** will be interpreted for calculation purposes as **10.0** if **dCpt** is set to **0.1**. If necessary adjustment for this can be made using the arithmetic formula.

5.25 Digital filter

Display: **FLtr**
Range: **0** to **8**
Default Value: **2**

Displays and sets the digital filter value. Digital filtering uses a weighted average method of determining the display value and is used for reducing display value variation due to short term interference. The digital filter range is selectable from **0** to **8**, where **0** = none and **8** = most filtering. Use **▲** or **▼** at the **FLtr** function to alter the filter level if required. Note that the higher the filter setting the longer the display may take to reach its final value when the input is changed, similarly the relay operation and any output options will be slowed down when the filter setting is increased. To set the digital filter value go to the **FLtr** function and use the **▲** or **▼** push buttons to set the required value then press **F** to accept this selection.



5.26 Number of active channels

Display: **Chno.**
Range: **1 to 3**
Default Value: **3**

Displays and selects the number of active input channels to be used. The instrument will automatically display functions only for the number of channels selected.



5.27 Decimal point for channel 1

Display: **Ch 1dCPt**
Range: **0, 0.1** etc.
Default Value: **0**

Displays and sets the individual decimal point setting for input channel 1. By pressing the  or  pushbutton at the **dCPt** function the decimal point position may be set. The display will indicate as follows: **0** (no decimal point), **0.1** (1 decimal place), **0.02** (2 decimal places) etc. Note if the decimal point is altered the channel will need to be recalibrated and alarm etc. settings checked. Note that in arithmetic mode all channels will be treated as having the same decimal points as Channel 0 for calculation purposes e.g. if the channel zero decimal point function (**dCPt**) is set to **0.02** and **Ch 1dCPt** is set to **0.1** then a value of **100.0** on channel 1 will be treated as a value of **10.00** when the arithmetic operation takes place.



5.28 Decimal point for channel 2

Display: **Ch 2dCPt**
Range: **0, 0.1** etc.
Default Value: **0**

Displays and sets the individual decimal point setting for input channel 2. By pressing the  or  pushbutton at the **dCPt** function the decimal point position may be set. The display will indicate as follows: **0** (no decimal point), **0.1** (1 decimal place), **0.02** (2 decimal places) etc. Note if the decimal point is altered the channel will need to be recalibrated and alarm etc. settings checked. Note that in arithmetic mode all channels will be treated as having the same decimal points as Channel 0 for calculation purposes e.g. if the channel zero decimal point function (**dCPt**) is set to **0.02** and **Ch 2dCPt** is set to **0.1** then a value of **100.0** on channel 2 will be treated as a value of **10.00** when the arithmetic operation takes place.

5.29 Decimal point for channel 3

Display: **Ch 3dCPt**
Range: **0, 0.1** etc.
Default Value: **0**

Displays and sets the individual decimal point setting for input channel 3. By pressing the  or  pushbutton at the **dCPt** function the decimal point position may be set. The display will indicate as follows: **0** (no decimal point), **0.1** (1 decimal place), **0.02** (2 decimal places) etc. Note if the decimal point is altered the channel will need to be recalibrated and alarm etc. settings checked. Note that in arithmetic mode all channels will be treated as having the same decimal points as Channel 0 for calculation purposes e.g. if the channel zero decimal point function (**dCPt**) is set

to **0.02** and **CH3DCPT** is set to **0.1** then a value of **100.0** on channel 3 will be treated as a value of **10.00** when the arithmetic operation takes place.

5.30 Channel 1 **EA1** value for arithmetic formula

Display: **EA1**
 Range: **-32727** to **32767**
 Default Value: **1**

Seen only in **SEt OPER = Arth** mode. Displays and sets the **EA1** value to be used in the arithmetic formula. If the number of display digits allows a range from **-32727** to **32767** is available for this function. This value is used together with the input value for channel 1, the **Eb1** and **EC1** to produce the a value to be used in the formula below:

$$\frac{EA1 * (Ch1 + Eb1)}{EC1} \left\{ \begin{array}{l} Add \\ Sub \\ Prod \\ d, U \\ hi gh \\ Lo \\ S, nE \\ CoS \\ C.SUB \end{array} \right\} \frac{EA2 * (Ch2 + Eb2)}{EC2} \left\{ \begin{array}{l} Add \\ Sub \\ Prod \\ d, U \\ hi gh \\ Lo \\ S, nE \\ CoS \\ C.SUB \end{array} \right\} \frac{EA3 * (Ch3 + Eb3)}{EC3}$$

Note: **A** and **C** are whole numbers, **b** has the same decimal place setting as its associated channel.

5.31 Channel 1 **Eb1** value for arithmetic formula

Display: **Eb1**
 Range: **-32727** to **32767**
 Default Value: **0**

Seen only in **SEt OPER = Arth** mode. Displays and sets the **Eb1** value to be used in the arithmetic formula. See function 5.30 for further details.

5.32 Channel 1 **EC1** value for arithmetic formula

Display: **EC1**
 Range: **-32727** to **32767**
 Default Value: **1**

Seen only in **SEt OPER = Arth** mode. Displays and sets the **EC1** value to be used in the arithmetic formula. See function 5.30 for further details.

5.33 Channel 2 **EA2** value for arithmetic formula

Display: **EA2**
 Range: **-32727** to **32767**
 Default Value: **1**

Seen only in **SEt OPER = Arth** mode. Displays and sets the **EA2** value to be used in the

arithmetic formula. See function 5.30 for further details.

5.34 Channel 2 **Eb2** value for arithmetic formula

Display: **Eb2**
Range: **-32727 to 32767**
Default Value: **0**

Seen only in **SEt OPER = Arth** mode. Displays and sets the **Eb2** value to be used in the arithmetic formula. See function 5.30 for further details.

5.35 Channel 2 **Ec2** value for arithmetic formula

Display: **Ec2**
Range: **-32727 to 32767**
Default Value: **!**

Seen only in **SEt OPER = Arth** mode. Displays and sets the **Ec2** value to be used in the arithmetic formula. See function 5.30 for further details.

5.36 Channel 3 **Ea3** value for arithmetic formula

Display: **Ea3**
Range: **-32727 to 32767**
Default Value: **!**

Seen only in **SEt OPER = Arth** mode. Displays and sets the **Ea3** value to be used in the arithmetic formula. See function 5.30 for further details.

5.37 Channel 3 **Eb3** value for arithmetic formula

Display: **Eb3**
Range: **-32727 to 32767**
Default Value: **0**

Seen only in **SEt OPER = Arth** mode. Displays and sets the **Eb3** value to be used in the arithmetic formula. See function 5.30 for further details.

5.38 Channel 3 **Ec3** value for arithmetic formula

Display: **Ec3**
Range: **-32727 to 32767**
Default Value: **!**

Seen only in **SEt OPER = Arth** mode. Displays and sets the **Ec3** value to be used in the arithmetic formula. See function 5.30 for further details.

5.39 Arithmetic operation between channels 1 and 2

Display: **OP 1**
Range: **Add, Sub, Prod, d, U, H, Gh, Lo, Si NE, COS** or **d, FF**
Default Value: **Add**

Displays the arithmetic operation to be undertaken between the formula for channels 1 and 2. See also function 5.30 which illustrates the formula.

Choices are:

- **Add** - channel 1 formula plus channel 2 formula
- **Sub** - channel 1 formula minus channel 2 formula
- **Prod** - channel 1 formula times channel 2 formula
- **d, U** - channel 1 formula divided by channel 2 formula
- **H, Gh** - highest of channel 1 formula or channel 2 formula
- **Lo** - lowest of channel 1 formula or channel 2 formula
- **Si, NE** - channel 1 formula times the sine of the angle represented by channel 2 formula
- **COS** - channel 1 formula times the cosine of the angle represented by channel 2 formula
- **d, FF** - difference between channel 1 and 2 (result is an absolute value)

5.40 Arithmetic operation between channel 3 and previous operation

Display: **OP2**
Range: **Add, Sub, Prod, d, U, H, Gh, Lo, Si NE, COS** or **d, FF**
Default Value: **Add**

Displays the arithmetic operation to be undertaken between the channel 3 formula and the previous result. See also function 5.30 which illustrates the formula.

Choices are:

- **Add** - mathematical result of **OP 1** plus channel 3 formula
- **Sub** - mathematical result of **OP 1** minus channel 3 formula
- **Prod** - mathematical result of **OP 1** times channel 3 formula
- **d, U** - mathematical result of **OP 1** divided by channel 3 formula
- **H, Gh** - highest of mathematical result of **OP 1** or channel 3 formula
- **Lo** - lowest of mathematical result of **OP 1** or channel 3 formula
- **Si, NE** - mathematical result of **OP 1** times the sine of the angle represented by channel 3 formula
- **COS** - mathematical result of **OP 1** times the cosine of the angle represented by channel 3 formula
- **d, FF** - difference between channel 1 **OP 1** channel 2 and channel 3 i.e. Difference between highest and lowest value of all channels (result is an absolute value).

5.41 Channel 0 polarity

Display: **CH0**
Range: **both, POS** or **NEG**
Default Value: **both**

Displays and sets the polarity selection for the display of the engineering value for channel 0. Channel 0 is the channel which displays the result of the arithmetic operations. If set to **BOTH** then the display will be able to indicate both positive and negative values. If set to **POS** the display will allow only positive values with any values below zero being rounded to zero. If set to **NEG** then the display will allow only negative values with any value above zero being rounded to zero. Channel 0 polarity applies to Arithmetic mode **ARITH** only.

5.42 Channel 1 polarity

Display: **CH1**
Range: **both, POS** or **NEG**
Default Value: **both**

Displays and sets the polarity selection for the display of the engineering value for channel 1. If set to **BOTH** then the display will be able to indicate both positive and negative values. If set to **POS** the display will allow only positive values with any values below zero being rounded to zero. If set to **NEG** then the display will allow only negative values with any value above zero being rounded to zero.

5.43 Channel 2 polarity

Display: **CH2**
Range: **both, POS** or **NEG**
Default Value: **both**

Displays and sets the polarity selection for the display of the engineering value for channel 2. See function 5.42 for further information.

5.44 Channel 3 polarity

Display: **CH3**
Range: **both, POS** or **NEG**
Default Value: **both**

Displays and sets the polarity selection for the display of the engineering value for channel 3. See function 5.42 for further information.

5.45 First calibration scaling point for channel 1 input

Display: **CH1CAL1**
Range: Any display value
Default Value: n/a

First scaling point for 2 point calibration scaling - See "Calibration" chapter 6.

5.46 Second calibration scaling point for channel 1 input

Display: CH1CAL2
Range: Any display value
Default Value: n/a

Second scaling point for 2 point calibration scaling - See “Calibration” chapter 6.

5.47 First calibration scaling point for channel 2 input

Display: CH2CAL1
Range: Any display value
Default Value: n/a

First scaling point for 2 point calibration scaling - See “Calibration” chapter 6.

5.48 Second calibration scaling point for channel 2 input

Display: CH2CAL2
Range: Any display value
Default Value: n/a

Second scaling point for 2 point calibration scaling - See “Calibration” chapter 6.

5.49 First calibration scaling point for channel 3 input

Display: CH3CAL1
Range: Any display value
Default Value: n/a

First scaling point for 2 point calibration scaling - See “Calibration” chapter 6.



5.50 Second calibration scaling point for channel 3 input

Display: CH3CAL2
Range: Any display value
Default Value: n/a

Second scaling point for 2 point calibration scaling - See “Calibration” chapter See “Calibration” chapter 6.

5.51 Uncalibrate channel 1

Display: UCAL CH1
Range: n/a
Default Value: n/a

Uncalibrate, resets calibration for channel 1 - required only when a calibration problem occurs and it is necessary to clear the calibration memory. At the UCAL CH1 function press the  and  buttons simultaneously. The message CAL CLR should be seen to indicate that the calibration memory has been cleared.

5.52 Uncalibrate channel 2

Display: **UCAL CH2**
Range: n/a
Default Value: n/a

Uncalibrate, resets calibration for channel 2 - required only when a calibration problem occurs and it is necessary to clear the calibration memory. At the **UCAL CH2** function press the **▲** and **▼** buttons simultaneously. The message **CAL CLR** should be seen to indicate that the calibration memory has been cleared.

5.53 Uncalibrate channel 3

Display: **UCAL CH3**
Range: n/a
Default Value: n/a

Uncalibrate, resets calibration for channel 3 - required only when a calibration problem occurs and it is necessary to clear the calibration memory. At the **UCAL CH3** function press the **▲** and **▼** buttons simultaneously. The message **CAL CLR** should be seen to indicate that the calibration memory has been cleared.

5.54 **P** button function

Display: **P.but**
Range: **NONE .H. .Lo.Hi Lo** or **ZEFO**
Default Value: **NONE**

P button function - The **P** button (5, 6 or 8 digit LED models only) may be set to operate some of the remote input functions. With the zero function to prevent accidental operation, the **P** button must be held pressed for 2-3 seconds before the display will zero. If both the remote input and **P** button function are operated simultaneously the **P** button will override the remote input. The functions below are as described in the **F.I NP** function below. Functions available are: **NONE .H. .Lo.Hi Lo** or **ZEFO**

5.55 Remote input function

Display: **F.I NP**
Range: **NONE .P.HLd .d.HLd .H. .Lo .Hi Lo .ZEFO .SP.Ac .No.Ac** or **dULL**
Default Value: **NONE**

Remote input function - When remote input terminals 7 and 8 are short circuited, via a switch, relay, keyswitch etc. the instrument will perform the selected remote input function. A message will flash (e.g. **ZEFO** to indicate which function has been selected when the remote input pins are short circuited. The remote input functions are as follows:

- **NONE** - no remote function required i.e. activating the remote input has no effect.
- **P.HLd** - rate peak hold. The display will show the peak rate value (highest positive value) only whilst the remote input terminals are short circuited i.e. the display value can rise but not fall whilst the input terminals are short circuited. The message **P.HLd** will appear briefly

every 8 seconds whilst the input terminals are short circuited to indicate that the peak hold function is active.

- **d.HLd** - rate display hold. The rate display value will be held whilst the remote input terminals are short circuited. The message **d.HLd** will appear briefly every 8 seconds whilst the input terminals are short circuited to indicate that the display hold function is active. The totaliser will still be active and will sample the live input rather than the held input whilst the rate is held i.e. the rate display hold does not affect the totaliser operation.
- **H** - rate peak memory. The rate peak value stored in memory will be displayed if the remote input terminals are short circuited, if the short circuit is momentary then the display will return to normal measurement after 20 seconds. If the short circuit is held for 2 to 3 seconds or the power is removed from the instrument then the memory will be reset.
- **Lo** - rate valley memory. The rate minimum value stored in memory will be displayed. Otherwise operates in the same manner as the **H** function described above.
- **H, Lo** - rate toggle between **H** and **Lo** displays. This function allows the remote input to be used to toggle between rate peak and valley memory displays. The first operation of the remote input will cause the peak memory value to be displayed, the next operation will give a valley memory display. **PH** or **PLo** will flash before each display to give an indication of display type.
- **ZEFO** - rate display zero. Zeroes the rate display when the remote input is shorted. The input at the time of the **ZEFO** operation will become the new zero point. The zero operation shifts the calibration in the same manner as a calibration offset operation.
- **SP.Ac** - setpoint access only. This mode blocks access to any functions except the alarm setpoint functions unless the remote input pins are short circuited or entry is made via **CAL** mode or if the **ACCS** function is set to either **EASY** or **ALL**.
- **No.Ac** - no access. This mode blocks access to all functions unless the remote input pins are short circuited or entry is made via **CAL** mode or if the **ACCS** function is set to **ALL**.
- **dULL** - display brightness control. The remote input can be used to change the display brightness. When this mode is selected the display brightness can be switched, via the remote input terminals, between the brightness level set at the **brgt** function and the brightness level set at the **dULL** function.

5.56 Access mode

Display: **ACCS**
Range: **OFF, EASY, NONE** or **ALL**
Default Value: **OFF**

Access mode - the access mode function **ACCS** has four possible settings namely **OFF, EASY, NONE** and **ALL**. If set to **OFF** the mode function has no effect on alarm relay operation. If set to **EASY** the “easy alarm access” mode will be activated. Refer to “Easy alarm relay adjustment access facility” section. If set to **NONE** there will be no access to any functions via **FUNC** mode, entry via **CAL** mode must be made to gain access to alarm and calibration functions. If set to **ALL** then access to all functions, including calibration functions, can be gained via **FUNC** mode.

5.57 Setpoint access mode

Display: **SPAC**
Range: **A1, A1-2** etc.
Default Value: **A1**

Setpoint access - seen only if more than 1 relay fitted. Sets the access via **FUNC** mode and “easy alarm access” mode to the alarm relay setpoints. The following choices are available:

A1 - Allows setpoint access to alarm 1 only.

A1-2 - Allows setpoint access to alarms 1 and 2 only.

A1-3 - Allows setpoint access to alarms 1, 2 and 3 etc. up to the maximum number of relays fitted.

The remote input function (**FINP**) must be set to **SPAC** for this function to operate. Note: Only the setpoints which have been given a value will be accessible e.g. if **A1H** is set to **OFF** then there will be no access to the **A1H** function when **SPAC** is used.



5.58 Alarm relay channel allocation

Display: **A1OPER, A2OPER** etc.
Range: **Arth, CH1, CH2** or **CH3**
Default Value: **Arth**

Alarm relay channel allocation - In scanning mode the selected alarm relay can be set to operate from either channel 1, channel 2 or channel 3. Select **CH1, CH2** or **CH3** for the required operation. In arithmetic mode the selected alarm relay can be set to operate from any of these channels but can alternatively be set to operate from the result of the arithmetic operation by selecting **Arth** at this function.

5.59 Scan period

Display: **SCAN PER d**
Range: **0** to **240**
Default Value: **0**

Seen only when **SEL OPER** function is set to **SCAN** operation mode. The scan rate set the automatic display scrolling period between channels and is selectable between 0 and 240 seconds. This setting affects the display scrolling only, not sample time or retransmission scan rates. If 0 seconds is selected then the instrument will not scan i.e. the display will show one channel. To alter the displayed channel, when the scan rate is set to 0, use the  or  push button. The display will flash **Ch1, Ch2** or **Ch3** before the reading (and periodically every 5 seconds) to indicate which channel is selected.

5.60 First analog output operation mode

Display: **FEC OPER**
Range: **Arth, Ch1, Ch2, Ch3, HI 9H, Lo, AUGE, S.PLS** or **S.FLY**
Default Value: **Ch1**

Displays and sets the operation of the recorder output when in scan mode. The **FEC-** and **FEC+** functions also need to be set as required for the recorder output to operate correctly. Note that when the retransmission mode is set to **HI 9H, Lo, AUGE, S.PLS** or **S.FLY** the retransmission

scaling will use the decimal point selection from channel 1 for all active channels e.g. with **FEC₋** set to **0.0** and **FEC₊** set to **100.0**, 20mA will be retransmitted for a channel 1 display of **100.0** and channel 2 display of **10.00** and a channel 3 display of **1.000** i.e. all three are treated as the same number as far as any of the retransmission output modes are concerned since they are all taken as having the decimal point in the same place as channel 1. With the retransmission mode set to **Arth**, **Ch 1**, **Ch 2** or **Ch 3** the **FEC₋** and **FEC₊** settings will take on the same number of decimal points as the channel selected. Allow 200mS, for each channel change, for the retransmission output to settle down if scanning. The selections available are as follows.

- **Arth** - causes the recorder output to retransmit the channel 0 value only (arithmetic result) - valid only in arithmetic (**Arth**) mode).
- **Ch 1** - causes the recorder output to retransmit the channel 1 value only.
- **Ch 2** - causes the recorder output to retransmit the channel 2 value only.
- **Ch 3** - causes the recorder output to retransmit the channel 3 value only.
- **HIGH** - causes the recorder output to retransmit whichever input channel is giving the highest reading at that time.
- **Lo** - causes the recorder output to retransmit whichever input channel is giving the lowest reading at that time.
- **AUSE** - causes the recorder output to retransmit the average value of all active channels.
- **S.PLS** - causes the recorder output to retransmit each active channel in turn. As an indication that a new scan cycle is beginning the output will drop to 4mA then rise to 20mA (or 0 to 1V/0 to 10V for voltage retransmission), this indication can be used to communicate to a PLC etc. that a new cycle is beginning. The time duration of the 20mA pulse is determined by the setting of the **FEC PULSE** function.

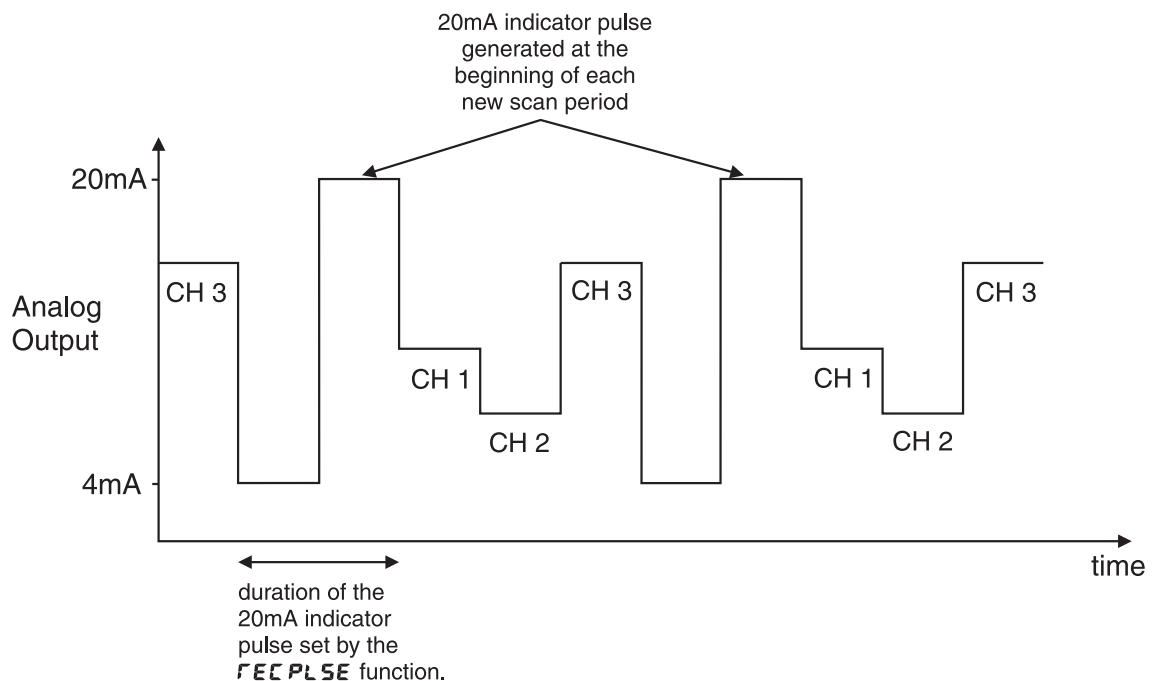

- **S.FLY** - causes the recorder output to retransmit each active channel in turn. An alarm relay contact closure (relay 1) is activated at the beginning of each new scan to give an indication to a PLC etc. that a new scan is beginning. The time duration of the relay closure is determined by the setting of the **FEC PULSE** function.

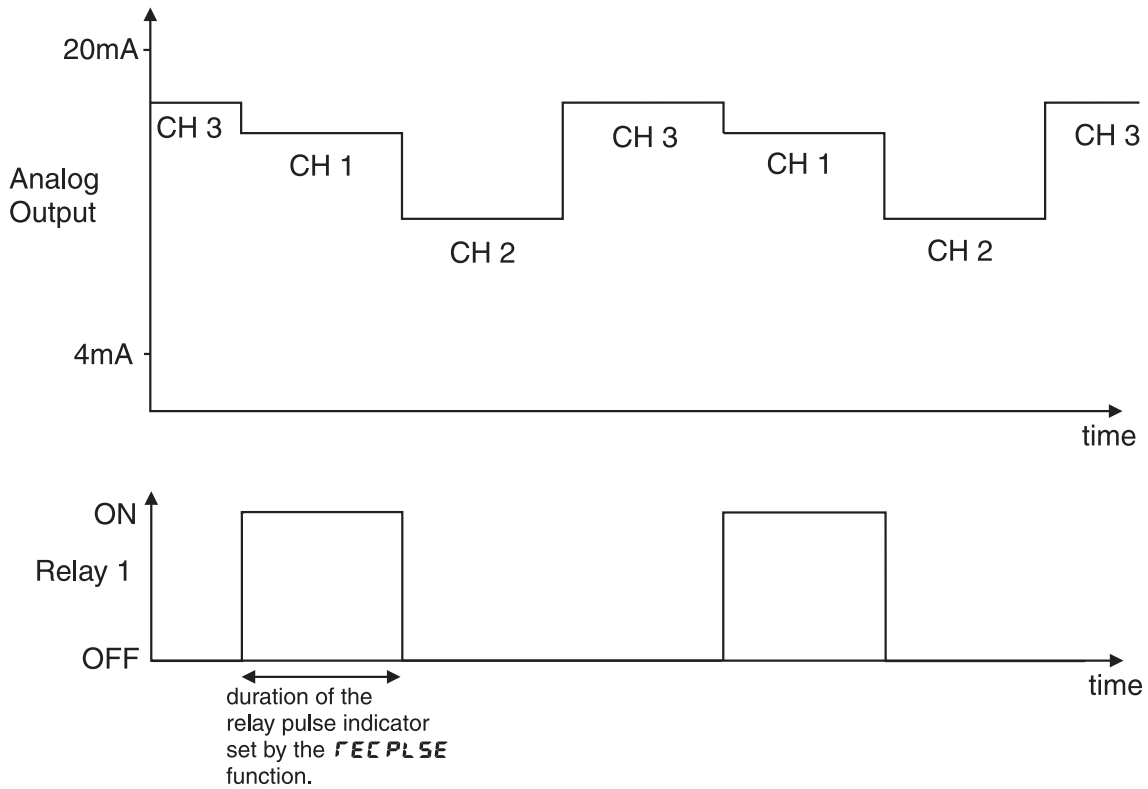

Refer to the separate “PM4 Panel Meter Optional Output Addendum” booklet for description of the analog PI control functions and wiring details.

5.61 First analog output pulse width

Display: **FEC PLSE**
 Range: **0 to 10**
 Default Value: **0**

Applicable only to **SCAN** operation mode. Refer to the separate PM4 Panel Meter Optional Output Addendum booklet supplied when this option is fitted. Displays and sets the time duration of the relay indicator closure (when **FEC OPEF** is set to **S.FLY**) or the 20mA indicator pulse (when **FEC OPEF** is set to **S.PLS**). The time is variable from 1 to 10 seconds. When the pulse width is increased or decreased the total retransmission time for each cycle will increased or decreased in proportion.

5.62 Second analog output operation mode

Display: **FEC2 OPEF**
 Range: **Arth, Ch 1, Ch 2, Ch 3, HI 9H, Lo, RUSE, S.PLS or S.FLY**
 Default Value: **Ch 1**

Sets operation mode for analog output 2 and has the same choice of modes as analog output 1, refer to **FEC OPEF** function 5.60 for details.

5.63 Second analog output pulse width

Display: **FEC2 PLSE**
Range: **0 to 10**
Default Value: **0**

Seen only when the optional dual analog retransmission is fitted. Sets the indicator pulse width for analog output 2 and has the same choices as analog output 1, refer to **FEC PLSE** function 5.61 for details.

5.64 Set operation mode

Display: **SET OPER**
Range: **ARITH** or **SCAN**
Default Value: **ARITH**

The set operating mode function allows the selection of either arithmetic (**ARITH**) or scanning (**SCAN**) mode operation. In arithmetic mode the selected inputs will be combined according to the arithmetic values and operation types selected and the display will indicate the result. In scanning mode the inputs will be scanned and displayed one at a time at a rate determined by the **SCAN PERIOD** function.

5.65 Baud rate for optional serial communications

Display: **BAUD RATE**
Range: **300 . 600 . 1200 . 2400 . 4800 . 9600 . 19.2** or **38.4**
Default Value: **9600**

Set baud rate - seen only with serial output option. Refer to the separate "PM4 Panel Meter Optional Output Addendum" booklet supplied when optional outputs are fitted. Select from **300 . 600 . 1200 . 2400 . 4800 . 9600 . 19.2** or **38.4** baud. The baud rate should be set to match the device being communicated with.

5.66 Parity for optional serial communications

Display: **PRTY**
Range: **NONE . EVEN** or **odd**
Default Value: **NONE**

Set parity - seen only with serial output option. Refer to the separate "PM4 Panel Meter Optional Output Addendum" booklet supplied when optional outputs are fitted. Select parity check to either **NONE**, **EVEN** or **odd**. The parity should be set to match the device being communicated with.

5.67 Output mode for optional serial communications

Display: **Output**
Range: **DI SP . Cont . POLL**, **A.buS** or **~.buS**
Default Value: **Cont**

Set serial interface mode - seen only with serial output option. Refer to the separate "PM4 Panel

Meter Optional Output Addendum” booklet supplied when optional outputs are fitted. Allows user to select the serial interface operation as follows:

d. SP - sends image data from the display without conversion to ASCII.

Cont - sends 8 bit ASCII form of display data at a rate typically 90% of the sample rate.

POLL - controlled by computer or PLC as host. Host sends command via RS232/485 and instrument responds as requested.

A.buS - is a special communications mode used with Windows compatible optional PC download software. Refer to the user manual supplied with this optional software.

ā.buS - Modbus RTU protocol.

5.68 Instrument address for optional serial communications

Display: **Addr**
Range: **0 to 31**
Default Value: **0**

Set unit address for polled (**POLL**) or **ā.buS** mode (**0 to 31**) - seen only with serial output option. Refer to the separate “PM4 Panel Meter Optional Output Addendum” booklet supplied when optional outputs are fitted. Allows several units to operate on the same RS485 interface reporting on different areas etc. if RS485 is available. The host computer or PLC may poll each unit in turn supplying the appropriate address. The unit address ranges from 0 to 31 (DEC) but is offset by 32 (DEC) to avoid clashing with ASCII special function characters (such as <STX> and <CR>). Therefore 32 (DEC) or 20 (HEX) is address 0, 42 (DEC) or 2A (HEX) is address 10. Do not use address 0 in **ā.buS** mode.

5.69 Returning to normal measure mode

When the calibration has been completed it is advisable to return the instrument to the normal mode (where calibration functions are less likely to be tampered with). To return to normal mode, turn off power to the instrument, wait a few seconds and then restore power.

6 Calibration

Each input channel (channel 1, 2 and 3) may be individually scaled/calibrated to display the inputs in engineering units. In arithmetic mode the primary display (channel 0) is then the result of the arithmetical function. For applications requiring less than three channels, the unused channel functions will not be displayed (note: channel number function **Chno** must be set to correct number of channels).

The decimal point position for each channel must be selected before calibrating each input. Whilst each channel can be allocated decimal point places independently in arithmetic mode the arithmetic calculation will assume that all channel decimal places are the same as the arithmetic channel (set by the **dCPE** function) e.g. a channel 1, 2 or 3 display of **1.00** will be interpreted for calculation purposes as **10.0** if **dCPE** is set to **0.1**. If necessary adjustment for this can be made using the arithmetic formula.

To enter the calibration mode follow the “Entering via **CAL** mode” instructions at the beginning of chapter 5.

Calibrating channel 1

1. Step through the functions until the display indicates **Ch1CAL1**.
2. Press the **▲** and **▼** buttons simultaneously to enter the calibration mode. The display will now indicate **Ch1CAL1** (1st calibration point) followed by the “live” reading. Apply a known input to the instrument of nominally 0% (this value is not critical and may be anywhere within the measuring range of the instrument).
3. When the reading has stabilised press the **F** button. The display will indicate **Ch1SCL1** (scale 1) followed by the scale value in memory.
4. Press the **▲** or **▼** button to obtain the required scale (calibration) value. Press the **F** button the display will now indicate **CAL End** (indicating that calibration of the first point is complete). The display will now indicate **Ch1CAL2** (2nd calibration point). Either step through the functions using the **F** button (to bypass the second calibration point) or enter the 2nd calibration mode as above by pressing the **▲** and **▼** buttons simultaneously.
5. Apply an input of 100% (again this value is not critical, for best accuracy should as far from the previous value as possible).
6. When the reading has stabilised, press the **F** button, the display will now indicate **Ch1SCL2** (scale 2) followed by the second scale value in memory. Press the **▲** or **▼** button to set the required scale value.
7. Press the **F** button, the display will now read **CAL End** (indicating that calibration of the second point is complete). The display will advance the channel 2 calibration function. Note: When entering the second point independently, the first calibration point may be bypassed, simply by pressing the **F** button instead of the **▲** and **▼** buttons simultaneously.

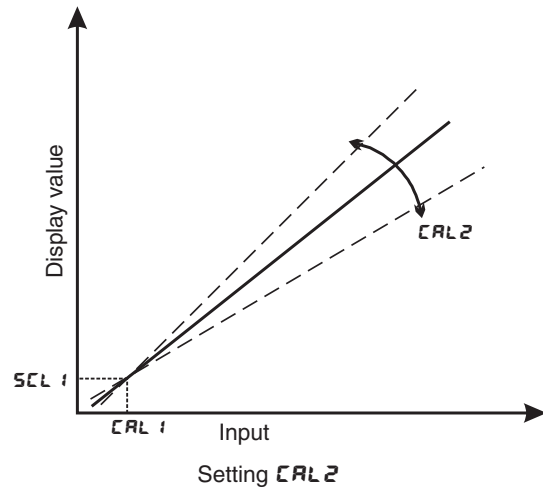
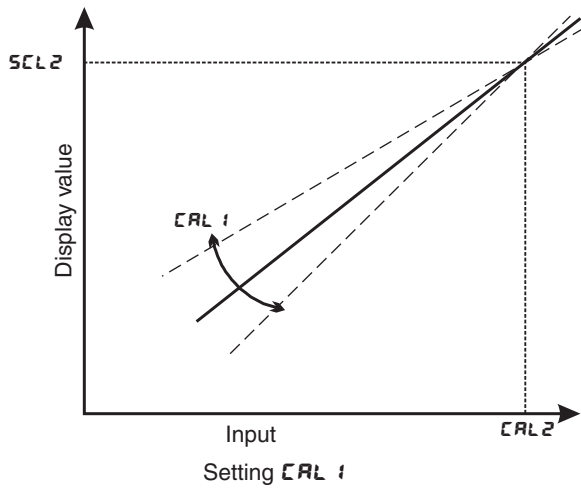

Calibration channel 2 and channel 3

Follow the procedure outlined for calibrating channel 1 using **CH2 CAL 1** and **CH2 CAL 2** for channel 2 and **CH3 CAL 1** and **CH3 CAL 2** for channel 3.

Returning to the normal measure mode

When the calibration procedure has been completed it is advisable to return the instrument to the normal mode (where calibration functions cannot be tampered with). To return to the normal mode, turn off power to the instrument, wait a few seconds and then restore power.

7 Arithmetic Functions

The PM4-IV3 may be set up to perform a variety of mathematical functions according to the equation:

$$\frac{EA1 * (Ch1 + Eb1)}{EC1} \left\{ \begin{array}{l} \text{Add} \\ \text{Sub} \\ \text{Prod} \\ \text{d, U} \\ \text{Hi 9h} \\ \text{Lo} \\ \text{Si, nE} \\ \text{CoS} \end{array} \right\} \frac{EA2 * (Ch2 + Eb2)}{EC2} \left\{ \begin{array}{l} \text{Add} \\ \text{Sub} \\ \text{Prod} \\ \text{d, U} \\ \text{Hi 9h} \\ \text{Lo} \\ \text{Si, nE} \\ \text{CoS} \end{array} \right\} \frac{EA3 * (Ch3 + Eb3)}{EC3}$$

The A, B and C value for each channel may be individually set in engineering units over the display range (note: A and C are whole numbers, B has the same decimal place as its associated channel). The display for each parameter is as follows:

EA1	EA2	EA3
Eb1	Eb2	Eb3
EC1	EC2	EC3

The operation of each channel may be set up as follows:

OP1 (channel 1 and channel 2)

- Add** channel 1 plus channel 2
- Sub** channel 1 minus channel 2
- Prod** channel 1 times channel 2
- d, U** channel 1 divided by channel 2
- Hi, 9h** highest of channel 1 or 2
- Lo** lowest of channel 1 or 2
- Si, nE** channel 1 times the sine of the angle displayed at channel 2
- CoS** channel 1 times the cosine of the angle displayed at channel 2
- d, FF** difference between channel 1 and 2 (result is an absolute value)

OP2 (result of channel 1 **OP1** channel 2 and channel 3)

- Add** result of (**Ch1 OP1 Ch2**) plus **Ch3**
- Sub** result of (**Ch1 OP1 Ch2**) minus **Ch3**
- Prod** result of (**Ch1 OP1 Ch2**) times **Ch3**
- d, U** result of (**Ch1 OP1 Ch2**) divided by **Ch3**
- Hi, 9h** highest of result of **Ch1 OP1 Ch2** or **Ch3**
- Lo** lowest of result of (**Ch1 OP1 Ch2**) or **Ch3**
- Si, nE** result of (**Ch1 OP1 Ch2**) times the sine of the angle displayed at channel 3
- CoS** result of (**Ch1 OP1 Ch2**) times the cosine of the angle displayed at channel 3
- d, FF** difference between **Ch1 OP1 Ch2** and **Ch3** (result is an absolute value)
i.e. Difference between highest and lowest value of all channels (result is an absolute value)

Note: channel 1 and channel 2 are calculated, then this result is calculated with channel 3.

The following examples may be used as a guide for setting up your instrument.

Example 1:

To get an average of channel 1 and channel 2 you need to divide Channel 1 by 2, divide channel 2 by 2 then add the two channels together:

Program settings: **EA1 = 1, Eb1 = 0, EC1 = 2, EA2 = 1, Eb2 = 0, EC2 = 2, OP1 = Add.**

$$\frac{1 * (\text{Ch1} + 0)}{2} \text{ Add } \frac{1 * (\text{Ch2} + 0)}{2}$$

Example 2:

To get a display in kVA with channel 1 representing Volts and channel 2 representing Amps we need to multiply channel 1 by channel 2 and divide by 1000:

Program settings: **EA1 = 1, Eb1 = 0, EC1 = 1000, EA2 = 1, Eb2 = 0, EC2 = 1, OP1 = Prod.**

$$\frac{1 * (\text{Ch1} + 0)}{1000} \text{ Prod } \frac{1 * (\text{Ch2} + 0)}{1}$$

Example 3:

To display true power in kW from inputs representing voltage and current the voltage is divided by 1000 then multiplied by the current then multiplied by the power factor. If channel 1 has an input representing the voltage, channel 2 has an input representing the current and channel 3 has an input representing the power factor then the settings required would be:

Program settings: **EA1 = 1, Eb1 = 0, EC1 = 1000, EA2 = 1, Eb2 = 0, EC2 = 1, EA3 = 1, Eb3 = 0, EC3 = 1, OP1 = Prod, OP2 = Prod.**

$$\frac{1 * (\text{Ch1} + 0)}{1000} \text{ Prod } \frac{1 * (\text{Ch2} + 0)}{1} \text{ Prod } \frac{1 * (\text{Ch3} + 0)}{1}$$

Alternatively if channel 3 input can be made to represent the phase angle θ then true power in kW can be calculated from $V/1000 * I * \text{Cos } \theta$.

$$\frac{1 * (\text{Ch1} + 0)}{1000} \text{ Prod } \frac{1 * (\text{Ch2} + 0)}{1} \text{ COS } \frac{1 * (\text{Ch3} + 0)}{1}$$

Example 4: To display the difference between the three inputs:

Program settings: **EA1 = 1, Eb1 = 0, EC1 = 1, EA2 = 1, Eb2 = 0, EC2 = 1, EA3 = 1, Eb3 = 0, EC3 = 1, OP1 = d, FF, OP2 = d, FF.**

$$\frac{1 * (\text{Ch1} + 0)}{1} \quad \mathbf{d, FF} \quad \frac{1 * (\text{Ch2} + 0)}{1} \quad \mathbf{d, FF} \quad \frac{1 * (\text{Ch3} + 0)}{1}$$

Example 5: To display channel 1 divided by (channel 2 times 40):

Program settings: **EA1 = 1, Eb1 = 0, EC1 = 1, EA2 = 40, Eb2 = 0, EC2 = 1, OP1 = d, U**

$$\frac{1 * (\text{Ch1} + 0)}{1} \quad \mathbf{d, U} \quad \frac{40 * (\text{Ch2} + 0)}{1}$$

8 Specifications

8.1 Technical specifications

Input type:	Link selectable 4 to 20mA or DC Volts 0-1V (range -2 to 2V), 0-10V (range -20 to 20V) or 0-100V (range -100 to 100V)
Impedance:	80Ω for mA input, 1MΩ for DC voltage input
ADC Resolution:	1 in 20,000
Accuracy:	0.1% of full scale when calibrated
Sample Rate:	1 sample every 2 seconds
Display update:	4 times per second
Conversion Method:	Dual Slope ADC
Microprocessor:	HC68HC11F CMOS
Ambient temperature:	LED -10 to 60° C, LCD -10 to 50° C
Humidity:	5 to 95% non condensing
Display:	LED Models: 4 digit 20mm, 5 digit 14.2mm + status LEDs + 4 way keypad. 6 digit 14.2mm + 4 way keypad LED Bar Graph 20 segment bar + 5 digit 7.6mm + relay status LEDs LED Circular Bar Graph 16 segment + 5 digit 7.6mm + relay status LEDs LCD Models: 4 digit 12.7mm, 6 digit 12.7mm
Power Supply:	AC 240V, 110V or 24V 50/60Hz or DC isolated wide range 12 to 48V. Special supply types 32VAC, 48VAC 50/60Hz or DC isolated 50 to 110V also available. Note: supply type is factory configured.
Power Consumption:	AC supply 4 VA max, DC supply typically 160mA at 12VDC and 80mA at 24VDC for PM4 with no optional outputs, actual current drawn depends on display type and options fitted
Output (standard):	1 x relay, Form A, rated 5A resistive 18VDC (approx.) non isolated regulated transmitter supply (25mA max.)
Relay Action:	Programmable N.O. or N.C or PI control (frequency or pulse width)

8.2 Optional outputs

Extra Relays:	Same specs. as Relay 1 (up to 6 extra relays). Available as one, three or six extra relays.
Analog Retransmission:	12 bit isolated 4 to 20mA, 0 to 1V or 0 to 10V link selectable (single or dual analog output versions available). (4-20mA will drive into resistive loads of up to 800Ω)
Digital Retransmission:	Isolated BCD/Binary
Serial Communications:	Isolated RS232 or RS485 (ASCII or Modbus RTU)
DC Voltage Output:	Isolated ±12V(24V) standard, ±5V(10V) link selectable (rated at 25mA).

8.3 Physical Characteristics

Bezel Size:	DIN 48mm x 96mm x 10mm
-------------	------------------------

Case Size:	44mm x 91mm x 120mm behind face of panel
Panel Cut Out:	45mm x 92mm +1mm/-0mm
Connections:	Plug in screw terminals (max. 2.5mm ² wire)
Weight:	400 gms basic model, 450 gms with option card

9 Guarantee and service

The product supplied with this manual is guaranteed against faulty workmanship for a period of two years from the date of dispatch.

Our obligation assumed under this guarantee is limited to the replacement of parts which, by our examination, are proved to be defective and have not been misused, carelessly handled, defaced or damaged due to incorrect installation. This guarantee is VOID where the unit has been opened, tampered with or if repairs have been made or attempted by anyone except an authorised representative of the manufacturing company.

Products for attention under guarantee (unless otherwise agreed) must be returned to the manufacturer freight paid and, if accepted for free repair, will be returned to the customers address in Australia free of charge.

When returning the product for service or repair a full description of the fault and the mode of operation used when the product failed must be given. In any event the manufacturer has no other obligation or liability beyond replacement or repair of this product.

Modifications may be made to any existing or future models of the unit as it may deem necessary without incurring any obligation to incorporate such modifications in units previously sold or to which this guarantee may relate.

This document is the property of the instrument manufacturer and may not be reproduced in whole or part without the written consent of the manufacturer.

This product is designed and manufactured in Australia.